



Free 8'x9' Sauna Plan

Free vs. Premium Plan: What's the Difference?

We offer both free and premium versions of our detailed shed plans, designed to fit your needs and budget. Check out the table below to see the key differences and choose the plan that's right for you:

Features	Free Plan	Premium Plan
Steps Count	9	23
Illustrations per Step	Limited	Every Step
Print Ready Format	X	✓
Step-by-Step Instructions	Basic	Comprehensive
Full Materials & Cutting List	X	✓
Additional Illustrations	X	✓
Additional Blueprints	X	✓
Tools List	X	✓
Fastening Elements List	X	✓
Technical Support	X	✓

[Try Premium Risk-Free](#)

60-day refund policy with no questions asked.

8'x9' Sauna shopping list

Material	Unit	Qty	Size
Lumber (1 x 2)	pcs	45	8'
Lumber (1 x 4)	pcs	8	8'
Lumber (1 x 4)	pcs	1	10'
Lumber (1 x 6)	pcs	1	10'
Lumber (2 x 2)	pcs	2	6'
Lumber (2 x 4)	pcs	63	8'
Lumber (2 x 4)	pcs	13	10'
Lumber (2 x 6)	pcs	8	8'
Lumber (2 x 8)	pcs	2	10'
OSB (1/2")	pcs	3	4' x 8'
Plywood siding (11/32")	pcs	8	4' x 8'

Size & Dimensions

front

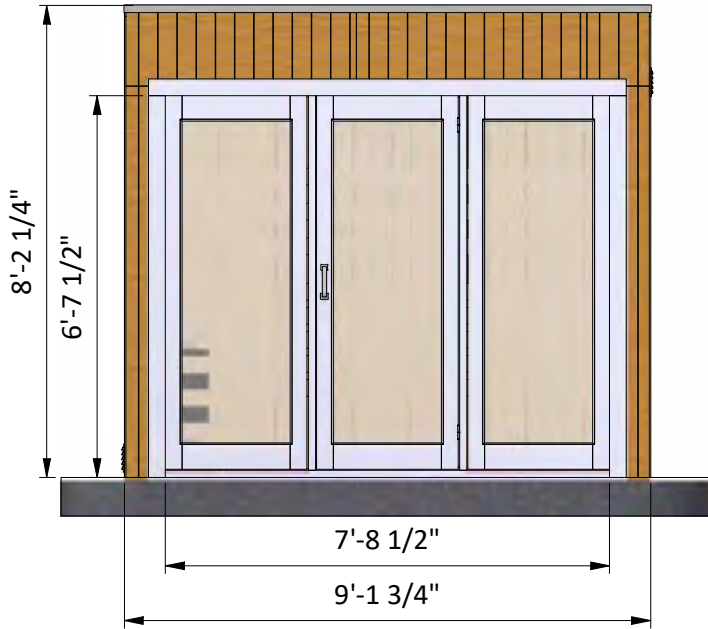

left

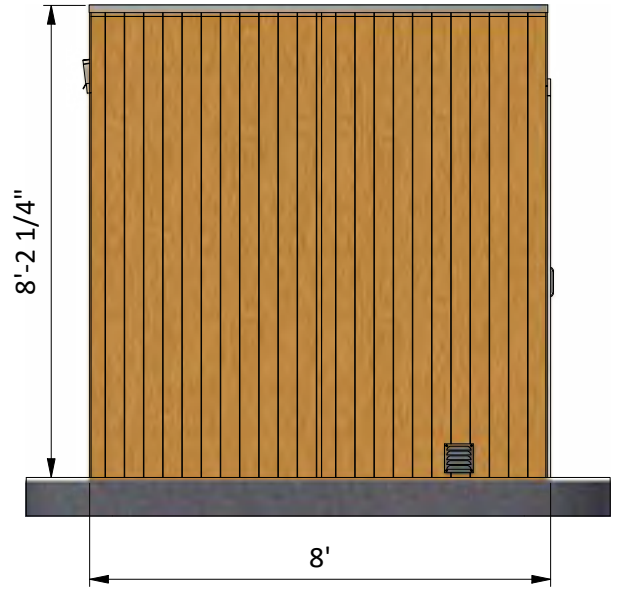

back

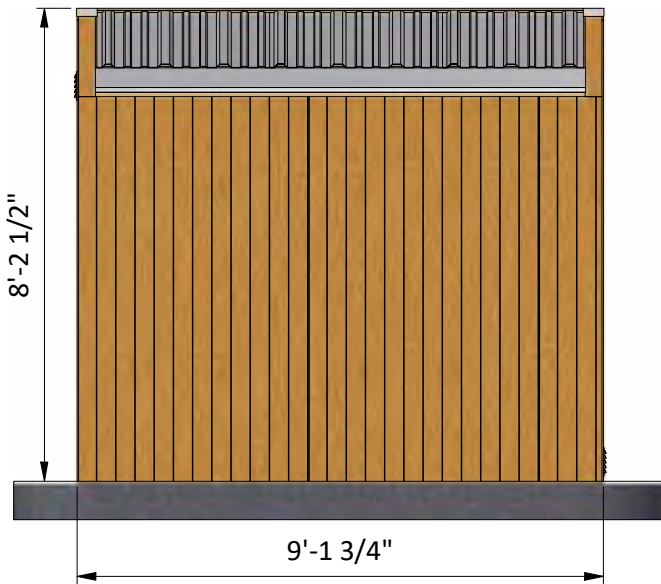

right

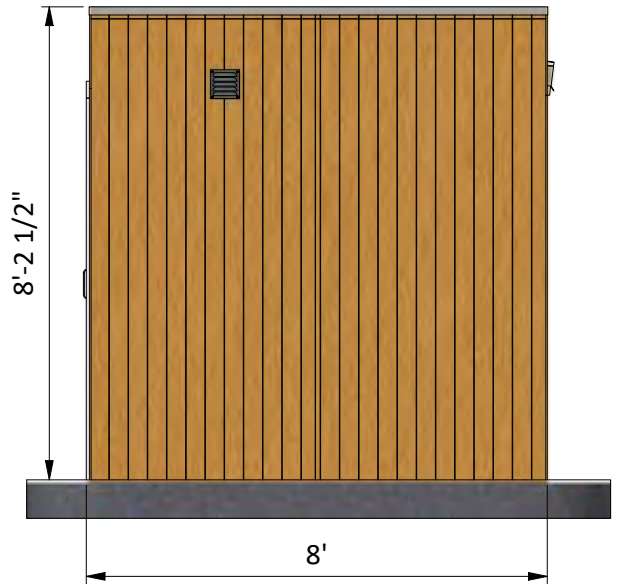

Interior view

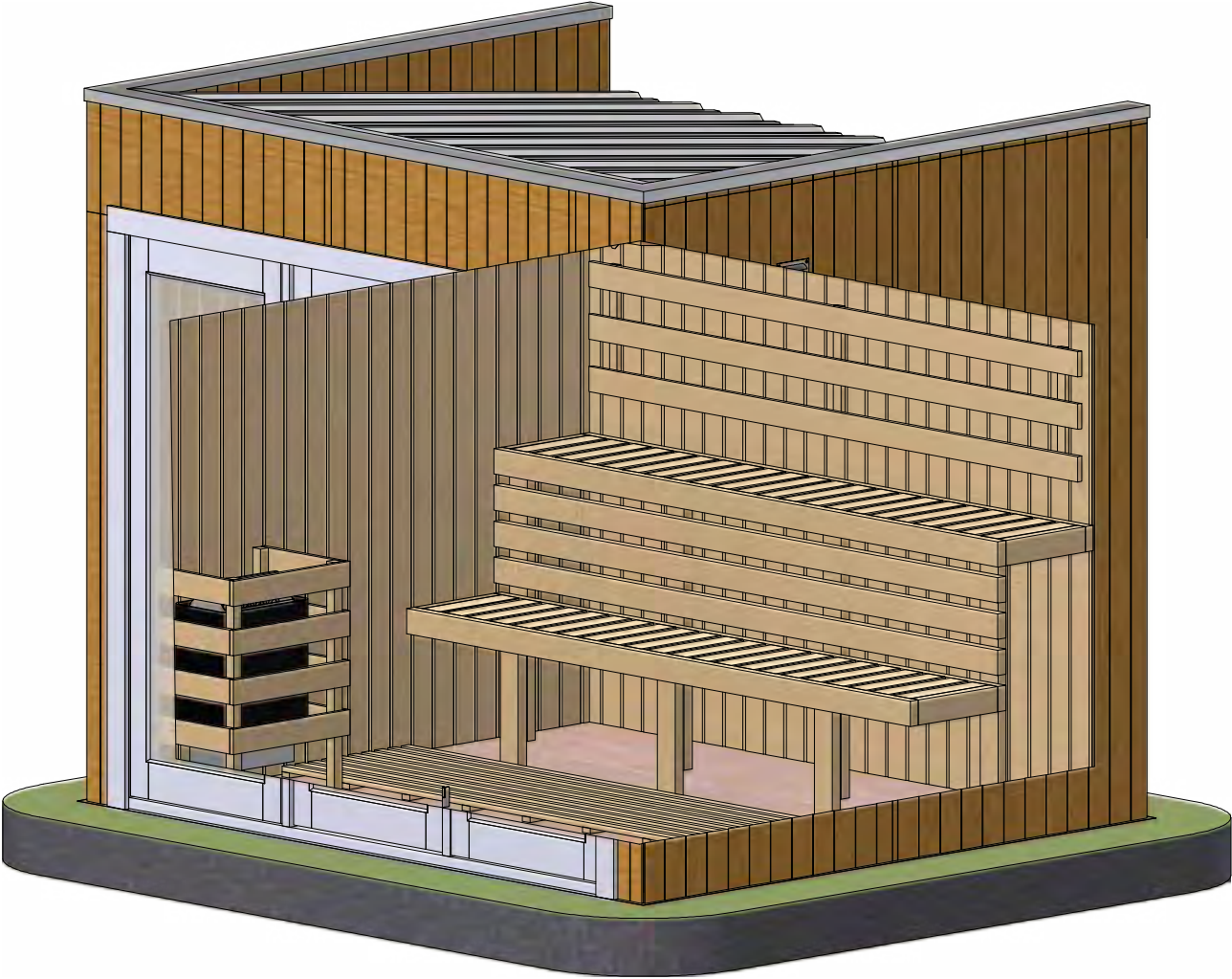

STEP 1

Foundation Preparation

1.1 Clear the area where you want to build the sauna and layout for the foundation. Use the illustration below as a guide.

1.2 For the slab, take off 4 inches of soil according to the drawings.

1.3 To reinforce the concrete slab, place number 4 reinforcement at 16 inch spacing and tie with binding wire at the intersection points of the resulting reinforcement mesh.

1.4 Fill the pit to ground level with concrete and let cure, or harden. Since curing times vary between brands, read the packaging for recommended curing times.

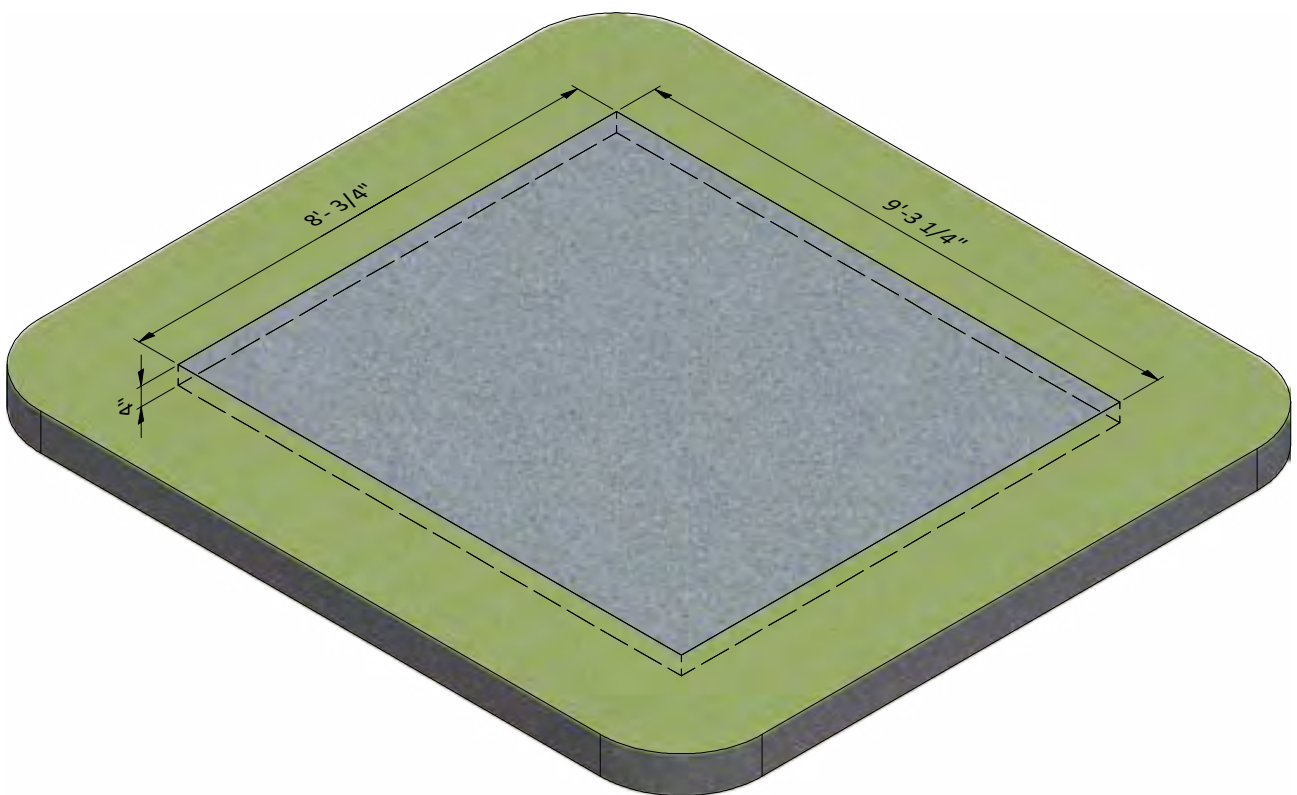

STEP 2

Assemble Left Wall Frame

2.1 Using 2x4 lumber, construct left wall frame using the drawing below as a reference. You will need to prepare beams in necessary quantity according to the cutting list below.

2.2 Connect the beams with 3" structural screws.

2.3 Using a speed square or carpenter's square, check the corners to make sure they are 90°.

Pos	Description	Material	Dimension	Qty
A	Stud	2x4	7'-11 1/4"	9
B	Top/ Bottom beam	2x4	7'-10 3/4"	2
C	Blocking board	2x4	1'-1 3/4"	1
D	Blocking board	2x4	1'-2 1/2"	5
E	Blocking board	2x4	1'-1/2"	1
F	Blocking board	2x4	5"	1

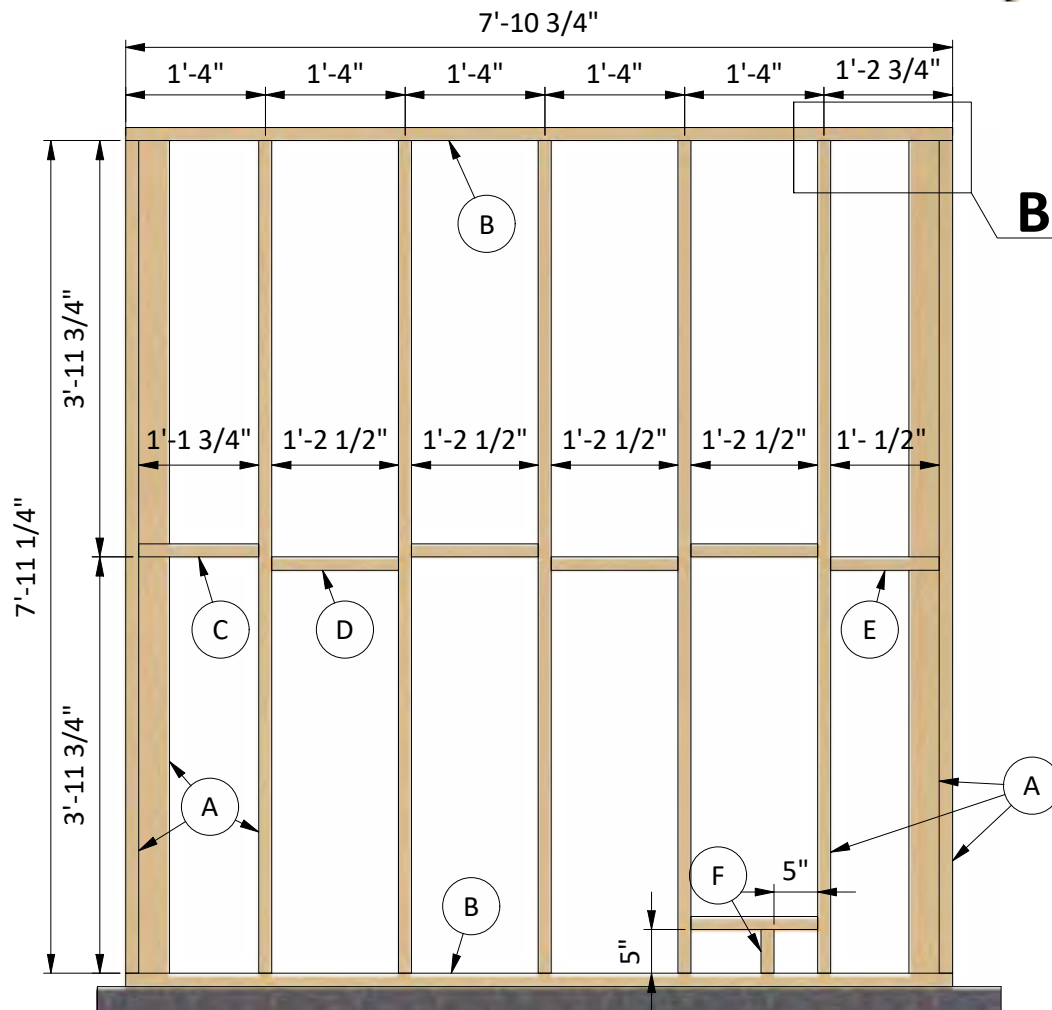
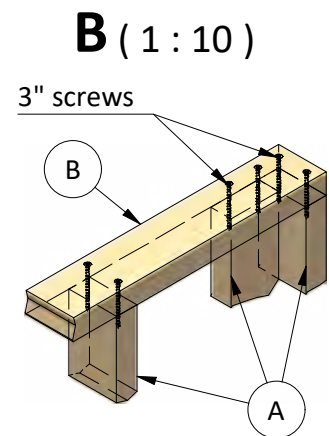

STEP 3

Assemble Right Wall Frame

3.1 Using 2x4 lumber, construct right wall frame using the drawing below as a reference. You will need to prepare beams in necessary quantity according to the cutting list below.

3.2 Connect the beams with 3" structural screws.

Pos	Description	Material	Dimension	Qty
A	Stud	2x4	7'-11 1/4"	9
B	Top/ Bottom beam	2x4	7'-10 3/4"	2
C	Blocking board	2x4	1'-1 3/4"	1
D	Blocking board	2x4	1'-2 1/2"	6
E	Blocking board	2x4	1'-1/2"	1
F	Blocking board	2x4	5"	1

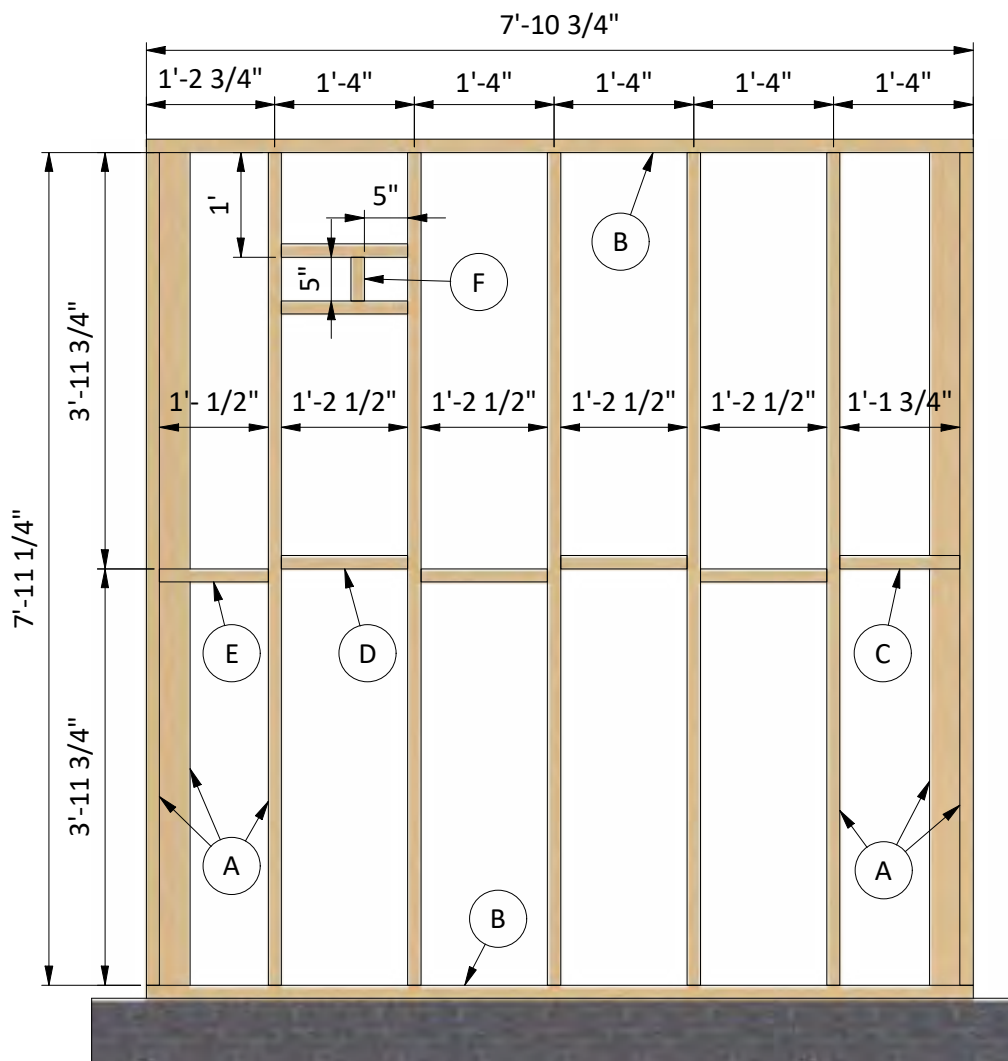

STEP 5

Assemble Back Wall Frame

5.1 Using 2x4 lumber, construct back wall frame using the drawing below as a reference. You will need to prepare beams in necessary quantity according to the cutting list below.

5.2 Connect the beams with 3" structural screws.

5.3 Using a speed square or carpenter's square, check the corners to make sure they are 90°.

Pos	Description	Material	Dimension	Qty
A	Stud	2x4	6'-4"	8
B	Top/Bottom beam	2x4	8'-6"	3
C	Blocking board	2x4	10 1/4"	1
D	Blocking board	2x4	1'-2 1/2"	5
E	Blocking board	2x4	7 1/4"	1

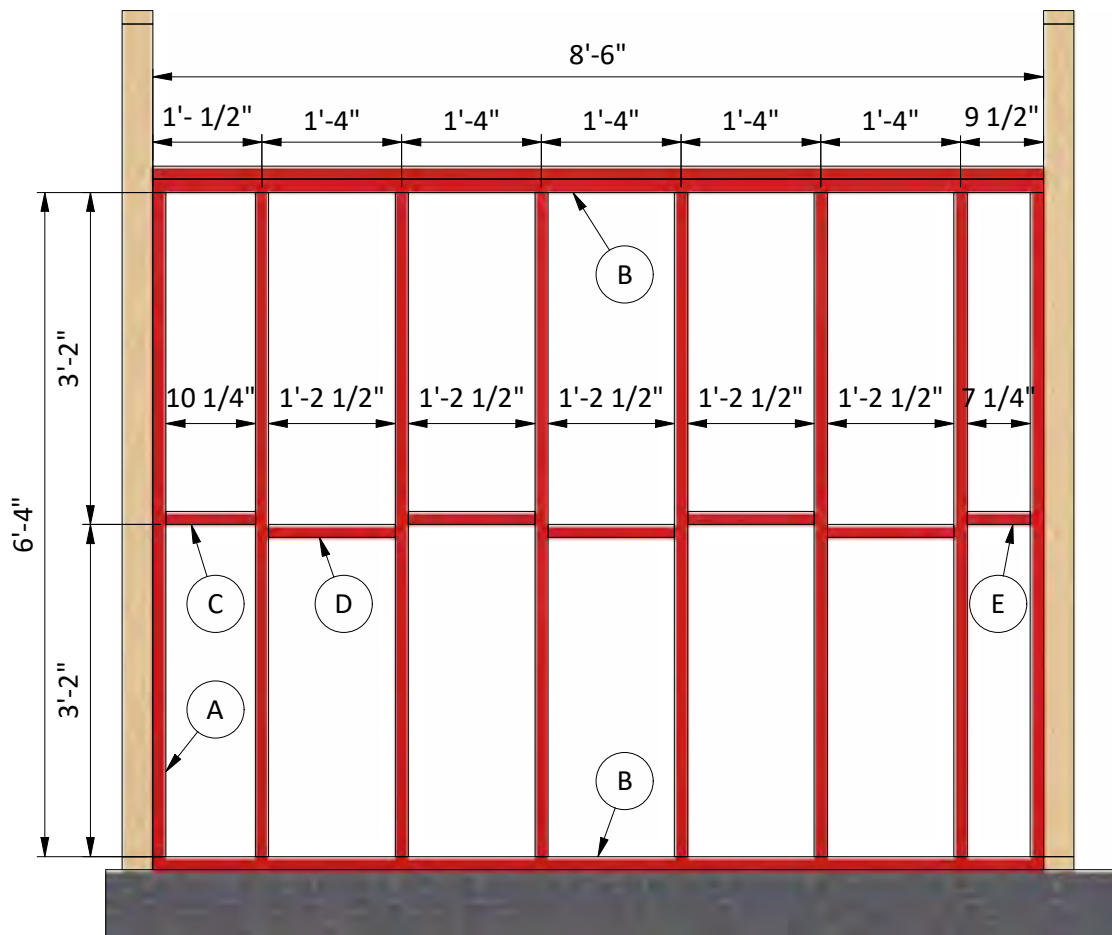

STEP 6

Assemble the Roof Frame

6.1 Using 2x6 lumber, cut six rafters according to the dimensions in drawings below.

6.2 Secure the rafters to the walls using H1 ties.

Pos	Description	Material	Dimension	Qty
A	Rafters	2x6	8'	6

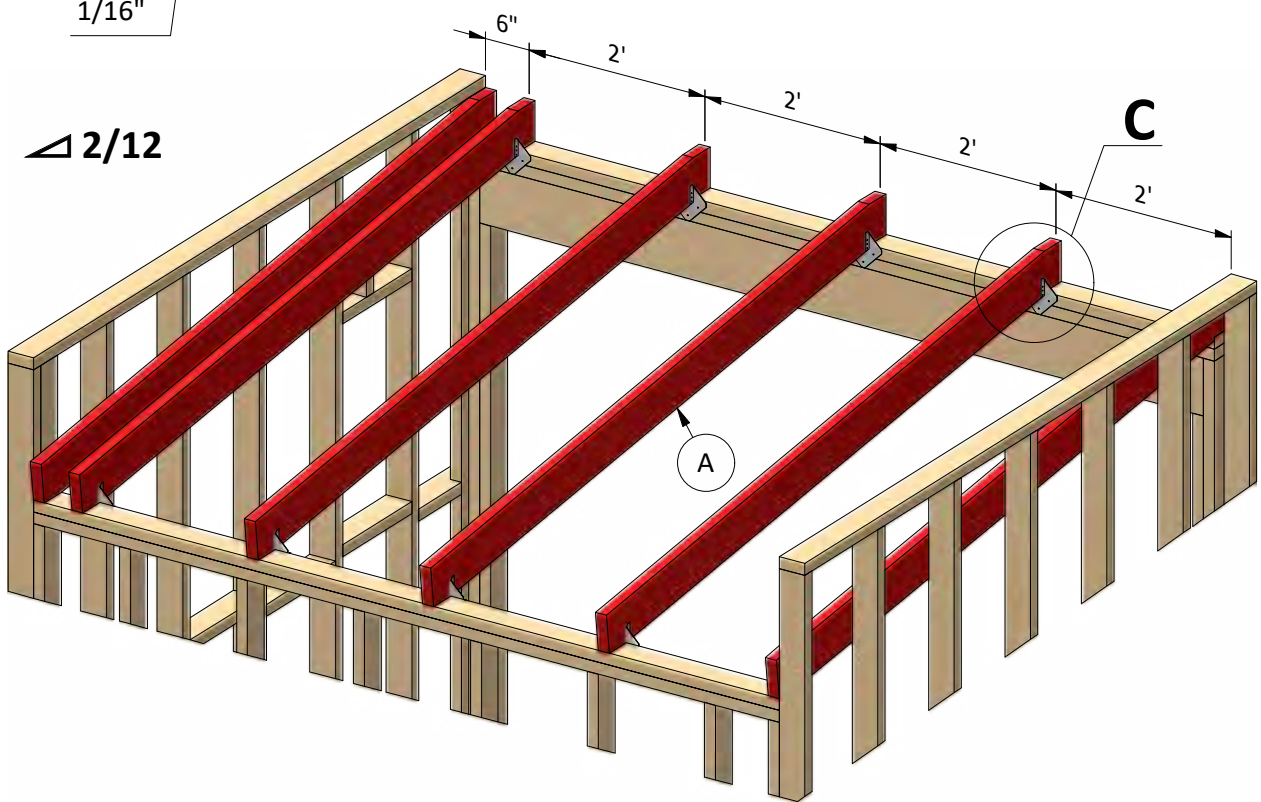
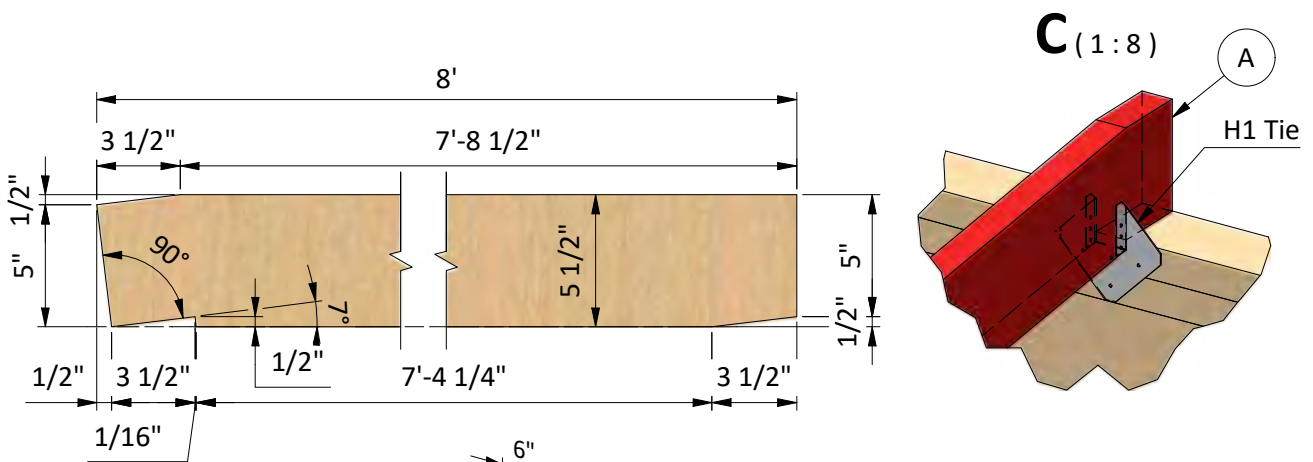

STEP 7

Assemble the Bench

7.1 Using 1x2, 1x4 and 2x4 lumber, assemble the bench using the drawing below as a reference. You will need to prepare beams in necessary quantity according to the cutting list below.

7.2 Connect the beams with 2" and 3" structural screws.

7.3 Using a speed square or carpenter's square, check the corners to make sure they are 90°.

Pos	Description	Material	Dimension	Qty
A	Bench rails	2x4	8'-3"	7
B	Seat splat	2x4	1'-3"	48
C	Support stud	2x4	1'-6 1/2"	3
D	Support stud	2x4	3'-2 1/2"	4
E	Backrest splats	1x4	8'	3
F	Girt	1x2	1'-6"	3

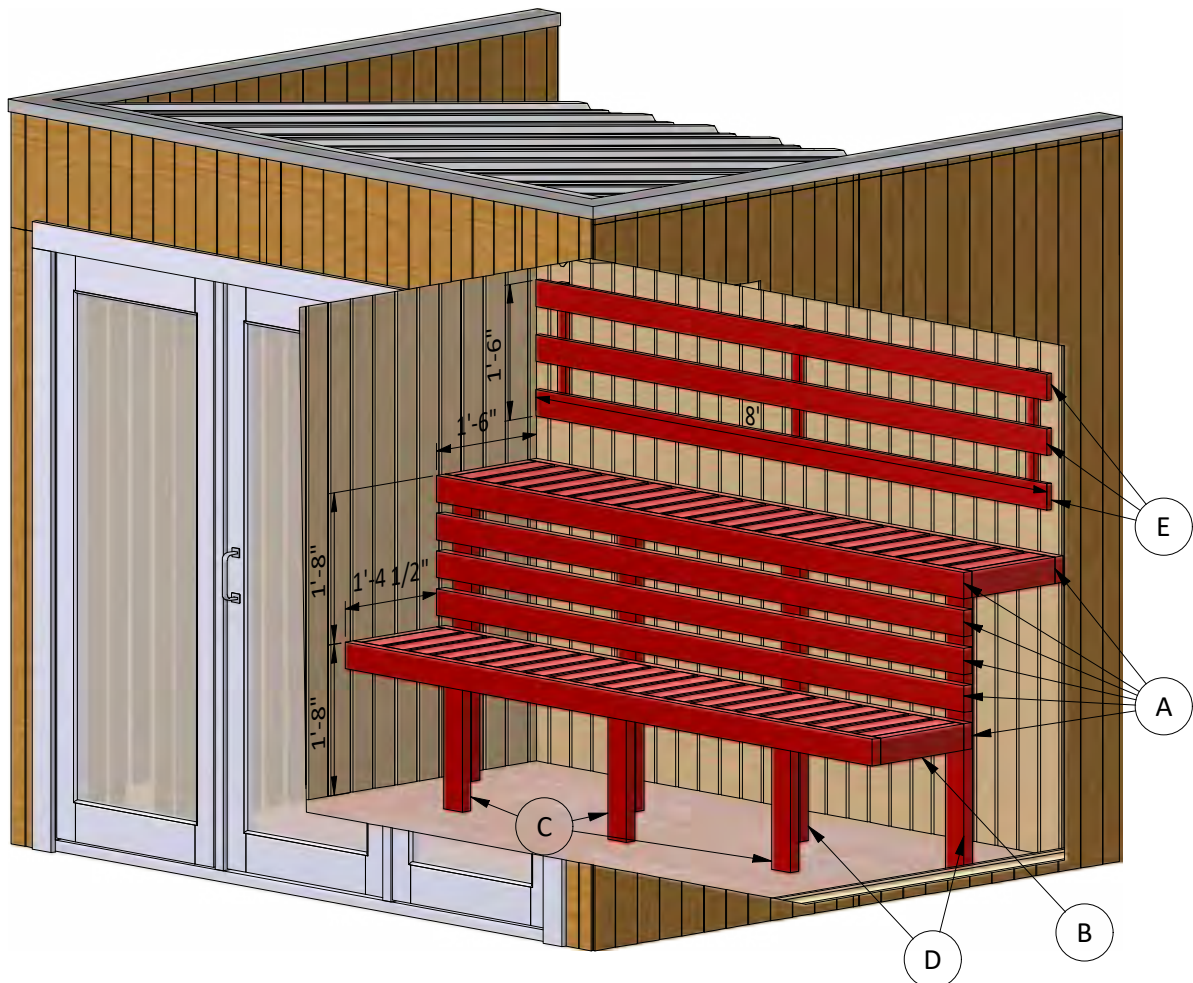

STEP 8

Assemble the Heater Fence

8.1 A heater with a capacity of approximately 9 kW is required for a sauna of this size (be sure to check your local codes regarding the installation of heating devices). Install it on the wall according to the manufacturer's instructions.

8.2 Using 1x4 and 2x2 lumber, assemble the fence around heater using the drawing below as a reference. You will need to prepare beams in necessary quantity according to the cutting list below.

Pos	Description	Material	Dimension	Qty
A	Rails	1x4	1'-10"	4
B	Rails	1x4	1'-4"	8
C	Support stud	2x2	2'	2
D	Middle post	2x2	2'-8"	2

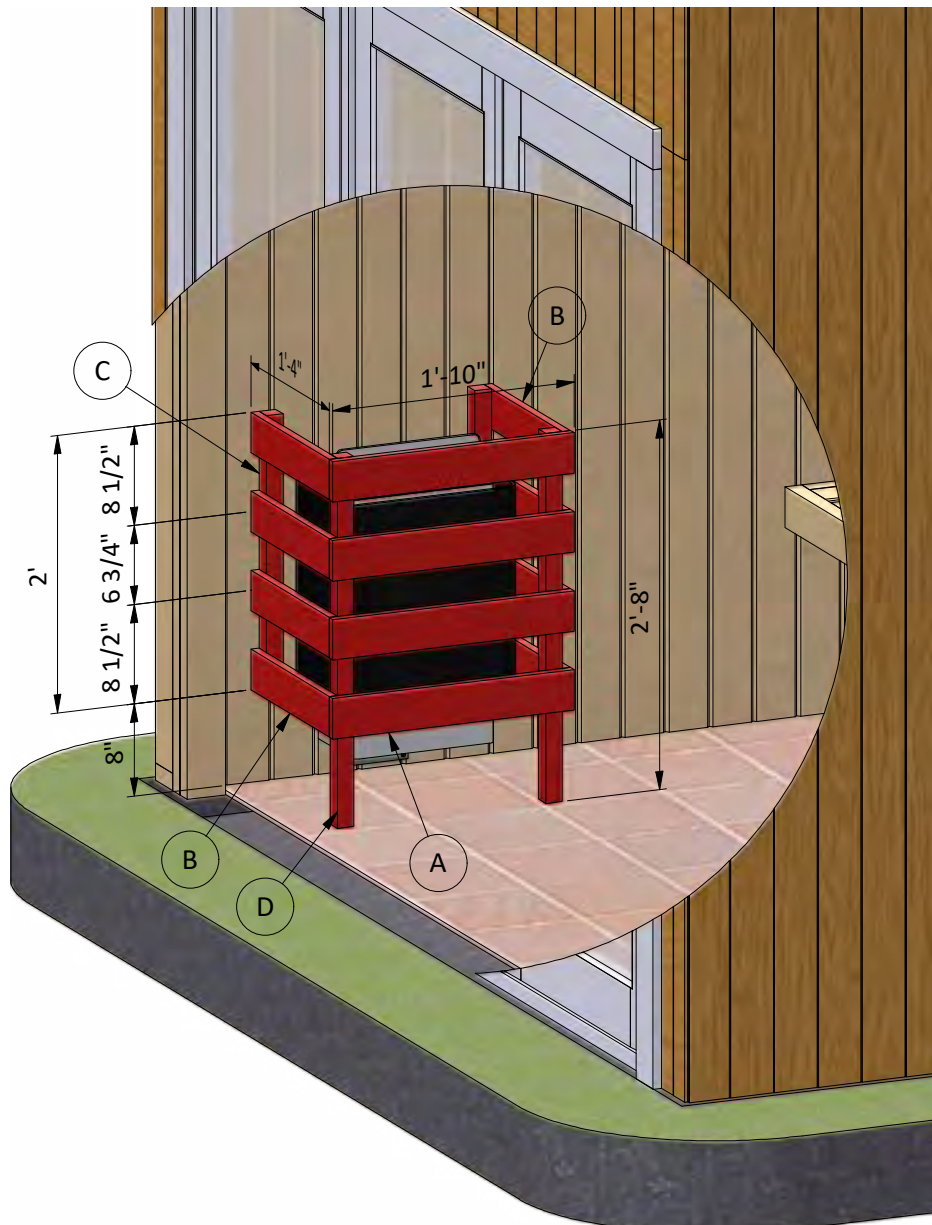

STEP 9

Final Touches

Now that your sauna is all done, you are ready to decorate it any way you want using your favorite paint, stain, or preservative.





For more great **HOW-TO** plans please visit: <https://craft.camp>

Copyright

The text and illustrations that appear here are the exclusive property of craft.camp and are protected by federal copyright laws. The duplication, sale or distribution of any portion of these plans without prior written consent from the original designer will be subject to the appropriate penalties for copyright infringement. Sharing this plan on the web is only permitted with an indicated original source: <https://craft.camp>