



Free 10' x 20' Chicken Coop Plan

Up to 20 chickens

Free vs. Premium Plan: What's the Difference?

We offer both free and premium versions of our detailed shed plans, designed to fit your needs and budget. Check out the table below to see the key differences and choose the plan that's right for you:

Features	Free Plan	Premium Plan
Metric measurements	X	✓
Illustrations per Step	Limited	Every Step
Print Ready Format	X	✓
Step-by-Step Instructions	Basic	Comprehensive
Full Materials & Cutting List	X	✓
Additional Illustrations	X	✓
Additional Blueprints	X	✓
Tools List	X	✓
Fastening Elements List	X	✓
Technical Support	X	✓

[Try Premium Risk-Free](#)

30-day refund policy with no questions asked.

10' x 20' chicken coop shopping list

Material	Unit	Qty	Size
Lumber (4 x 4)	Pcs	2	10'
Lumber (4 x 4)	Pcs	2	8'
Lumber (2 x 6)	Pcs	11	12'
Lumber (2 x 6)	Pcs	1	8'
Lumber (2 x 4)	Pcs	27	10'
Lumber (2 x 4)	Pcs	29	8'
Lumber (1 x 6)	Pcs	8	10'

Size & Dimensions

Front

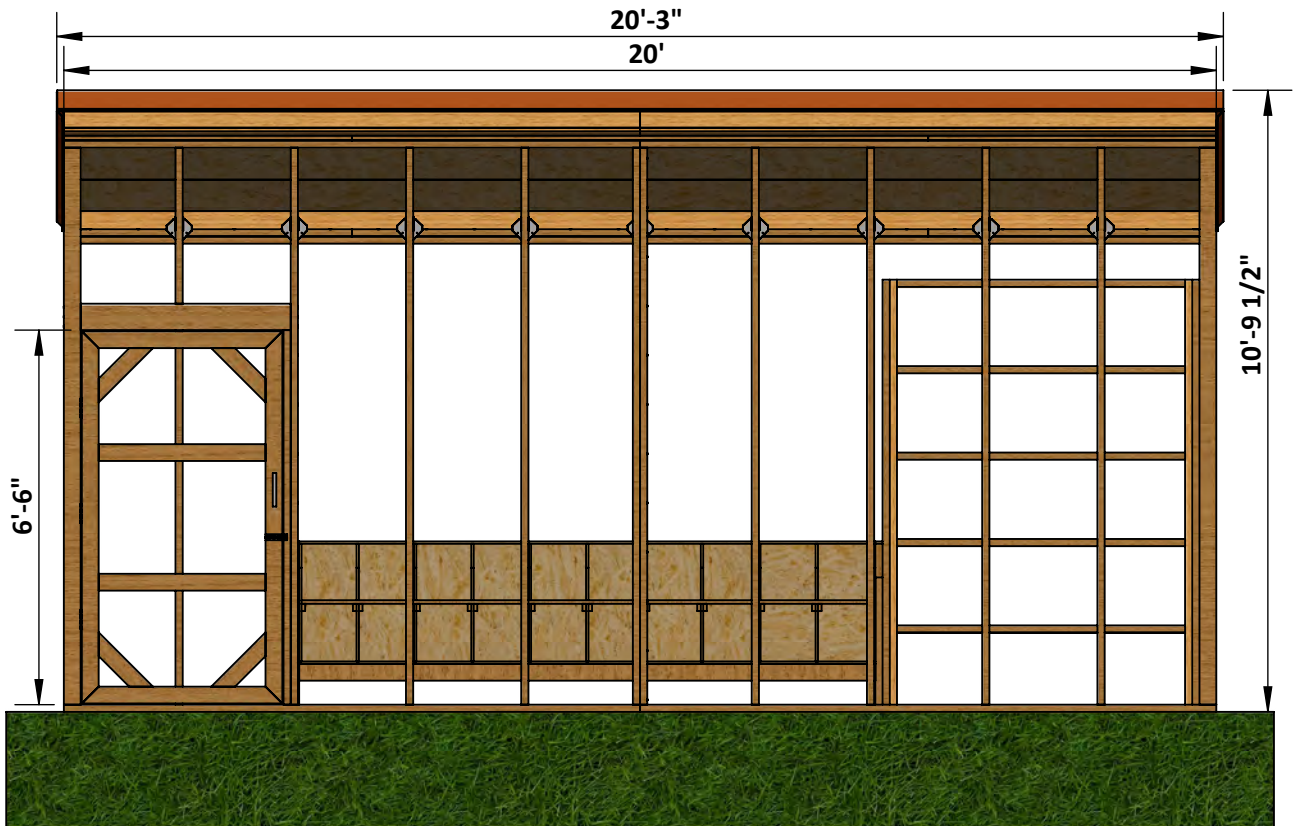

Right

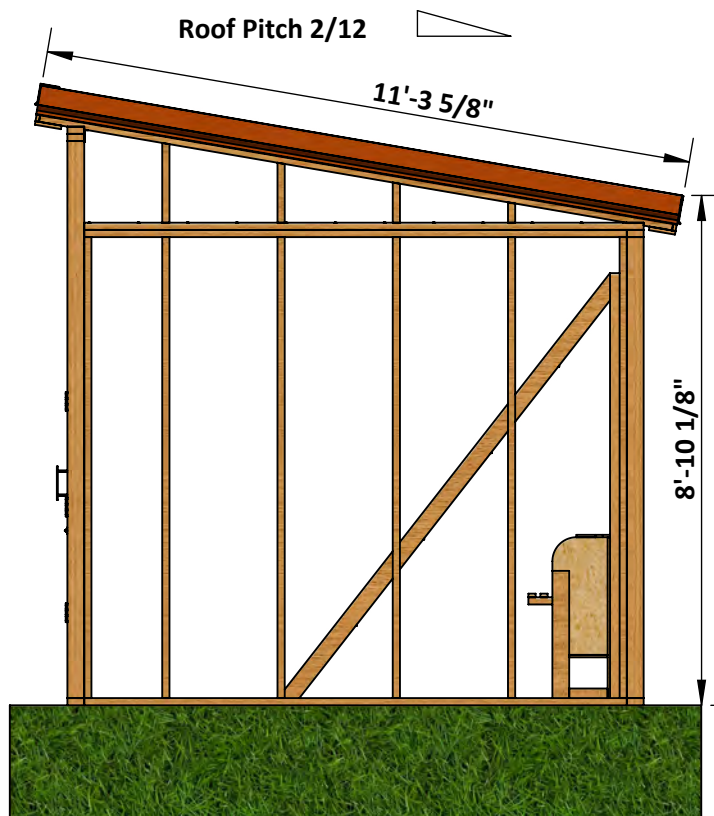

Size & Dimensions

Back

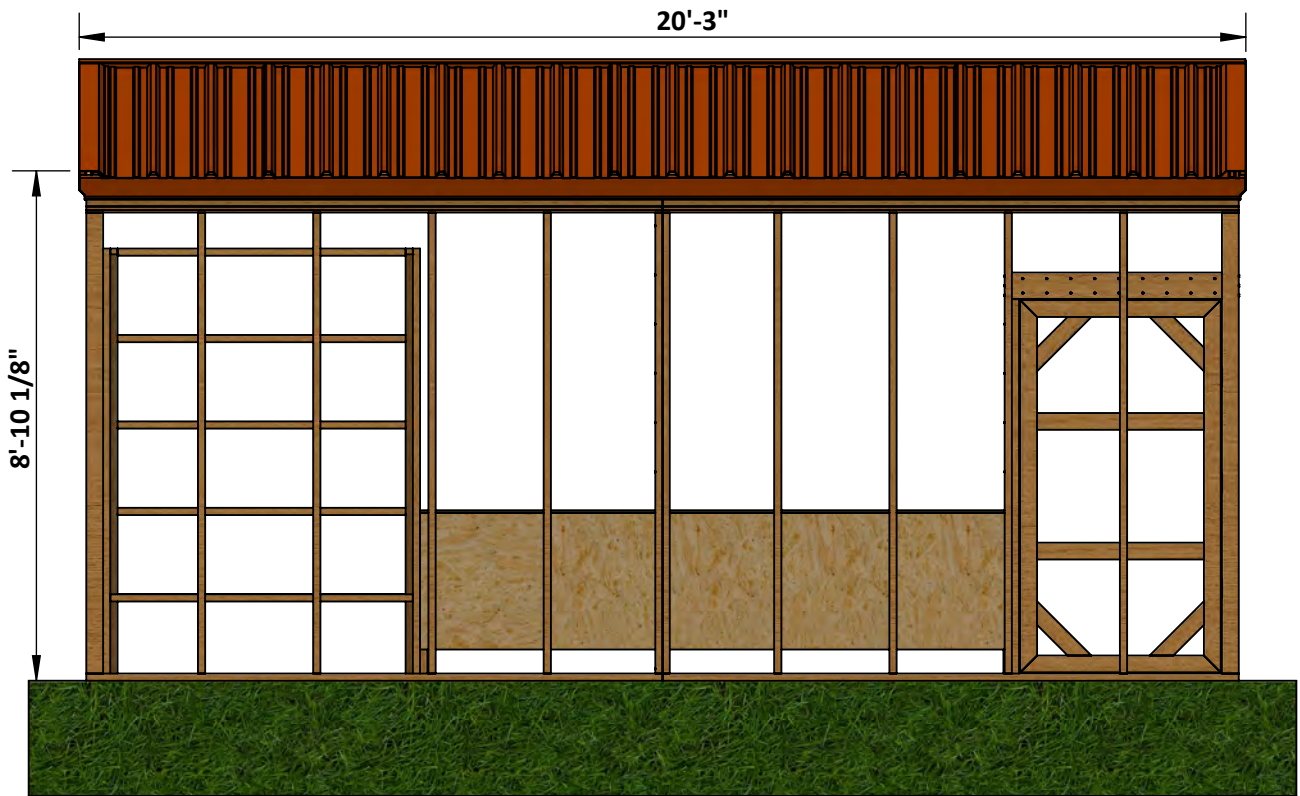

Left

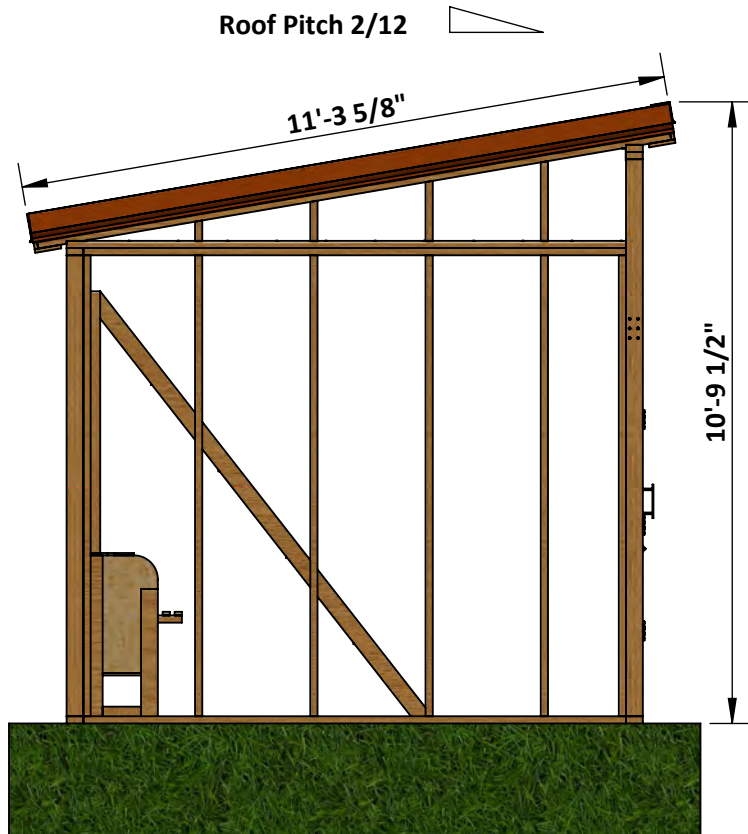

Interior View

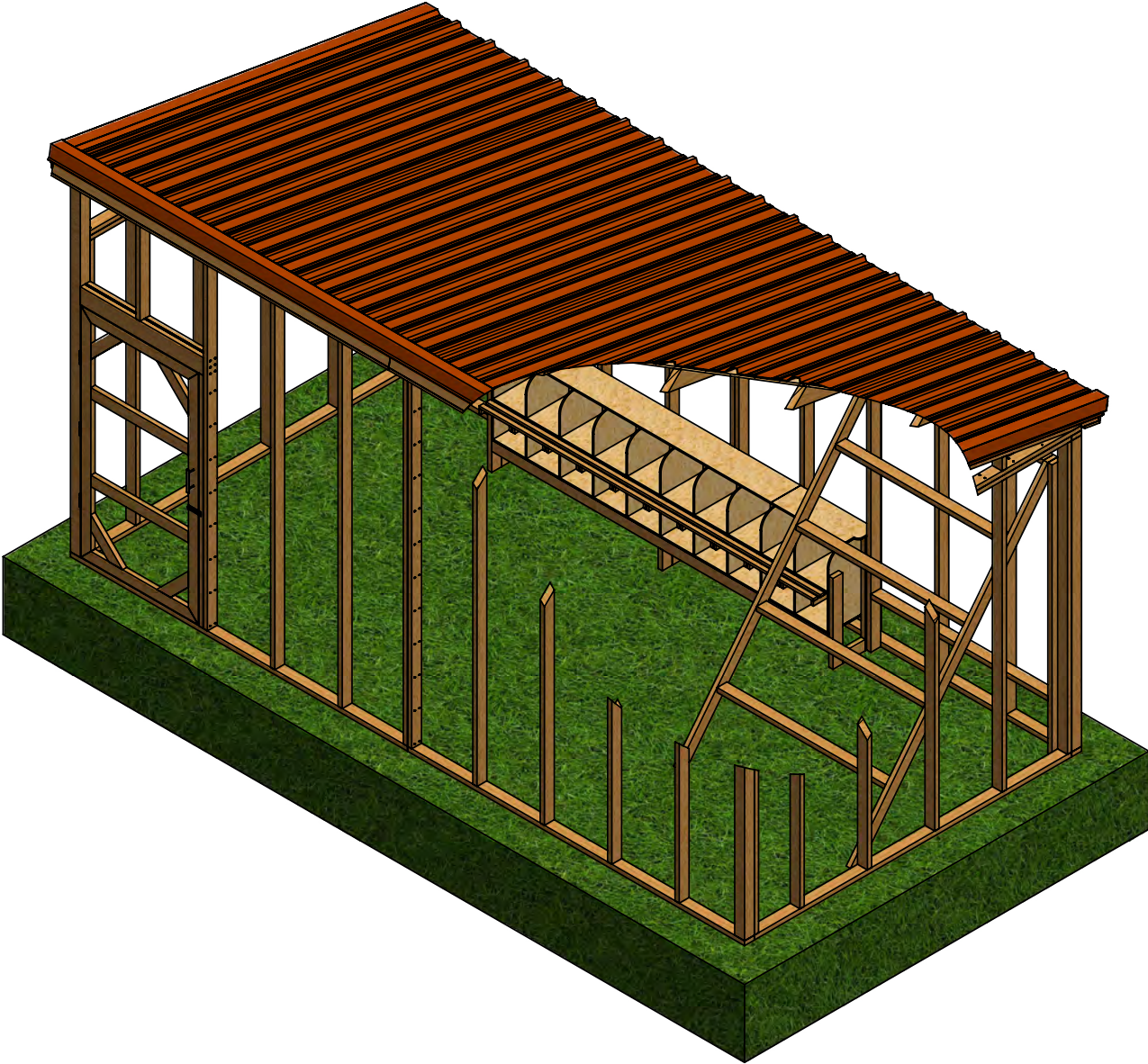

STEP 1

Back Wall Frame Assembly

1.1 Assemble the frame using 2 x 4 and 4 x 4 lumber.

1.2 Secure the beams and studs with 3" wood screws.

Pos	Description	Material	Dimension	Qty
A	Studs	4 x 4	8'	2
B	Top/Bottom Beam	2 x 4	10'	4
C	Studs	2 x 4	8'	10

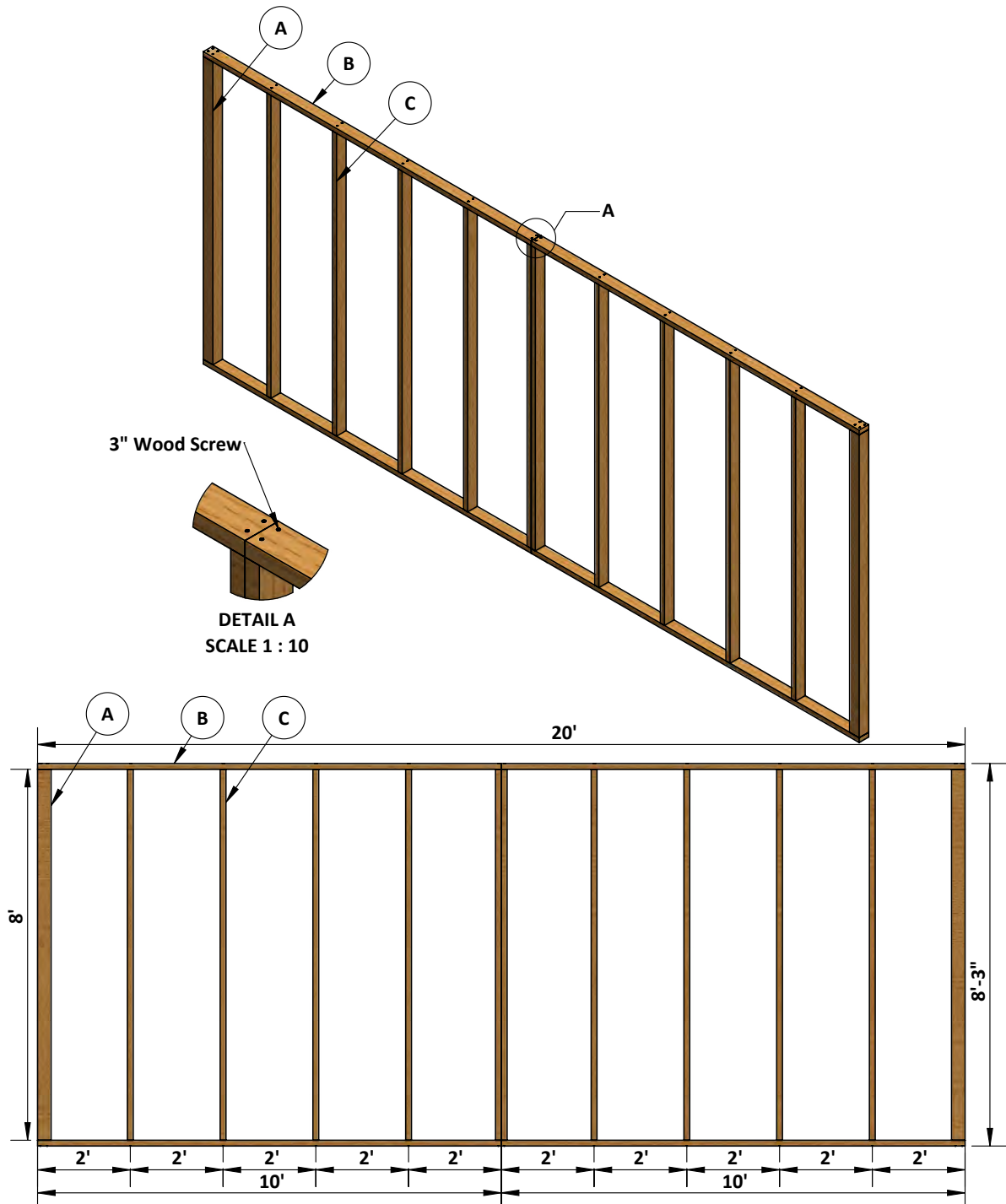

STEP 2

Side Wall Frame (Left & Right) Assembly

2.1 Assemble the frame using 2 x 4 lumber attached in Left and Right side.

2.2 Secure the beams and studs with 3" wood screws.

Pos	Description	Material	Dimension	Qty
A	Studs	2 x 4	8'	12
B	Top/Bottom Beam	2 x 4	9'-5"	4

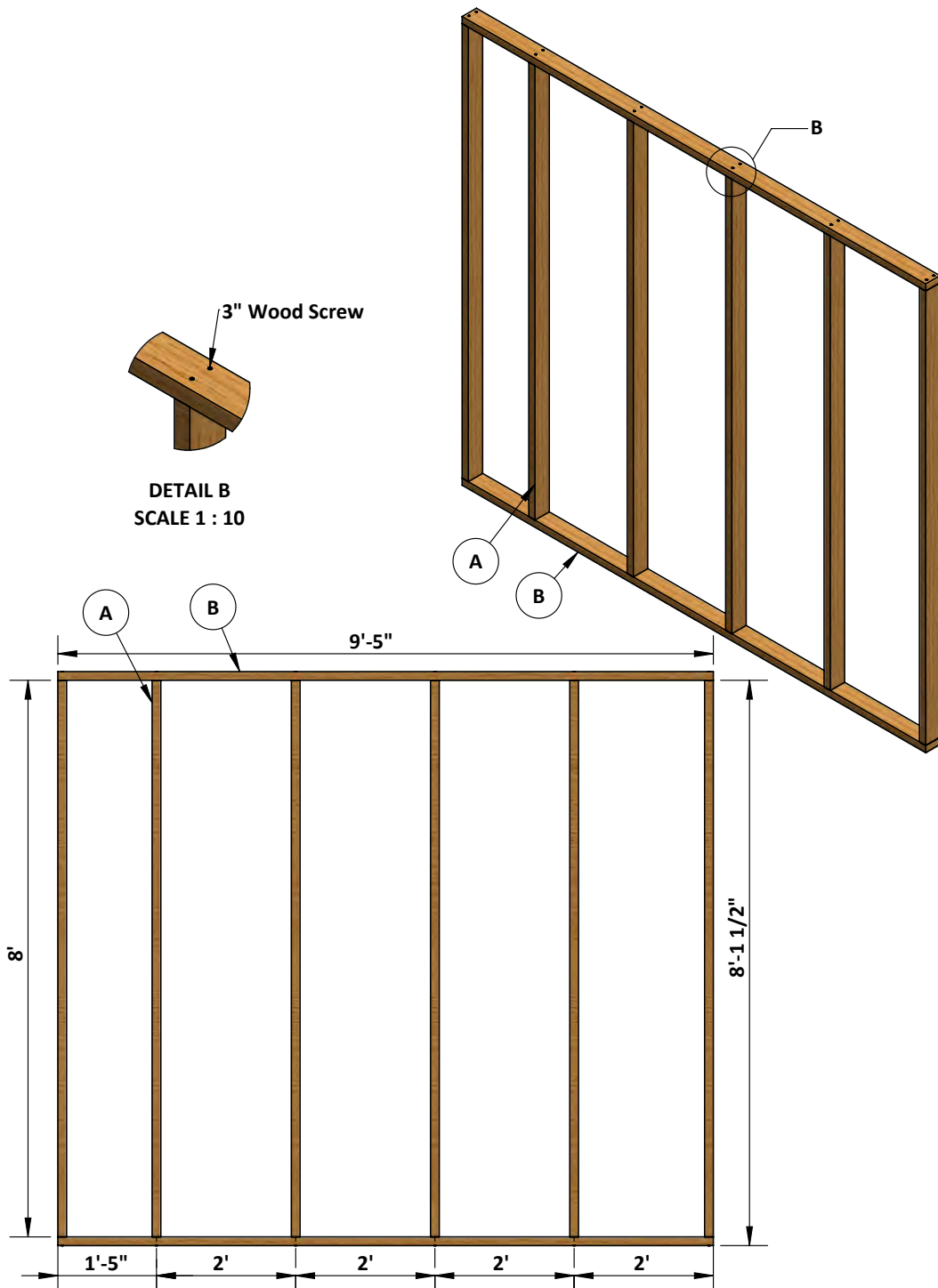

STEP 3

Front Wall Frame Assembly

3.1 Assemble the frame using 2 x 4, 2 x 6 and 4 x 4 lumber.

3.2 Secure the beams, Door Header and studs with 3" and 5" wood screws.

Pos	Description	Material	Dimension	Qty
A	Studs	4 x 4	9'-8"	2
B	Top/Bottom Beams	2 x 4	10'	4
C	Studs	2 x 4	9'-8"	9
D	Door Header	2 x 6	3'-7 3/4"	2
E	Door Header	OSB 1/2"	5 1/2" x 3'-7 3/4"	1
F	Stud	2 x 4	2'-8 1/2"	1
G	Stud	2 x 4	6'-6"	1

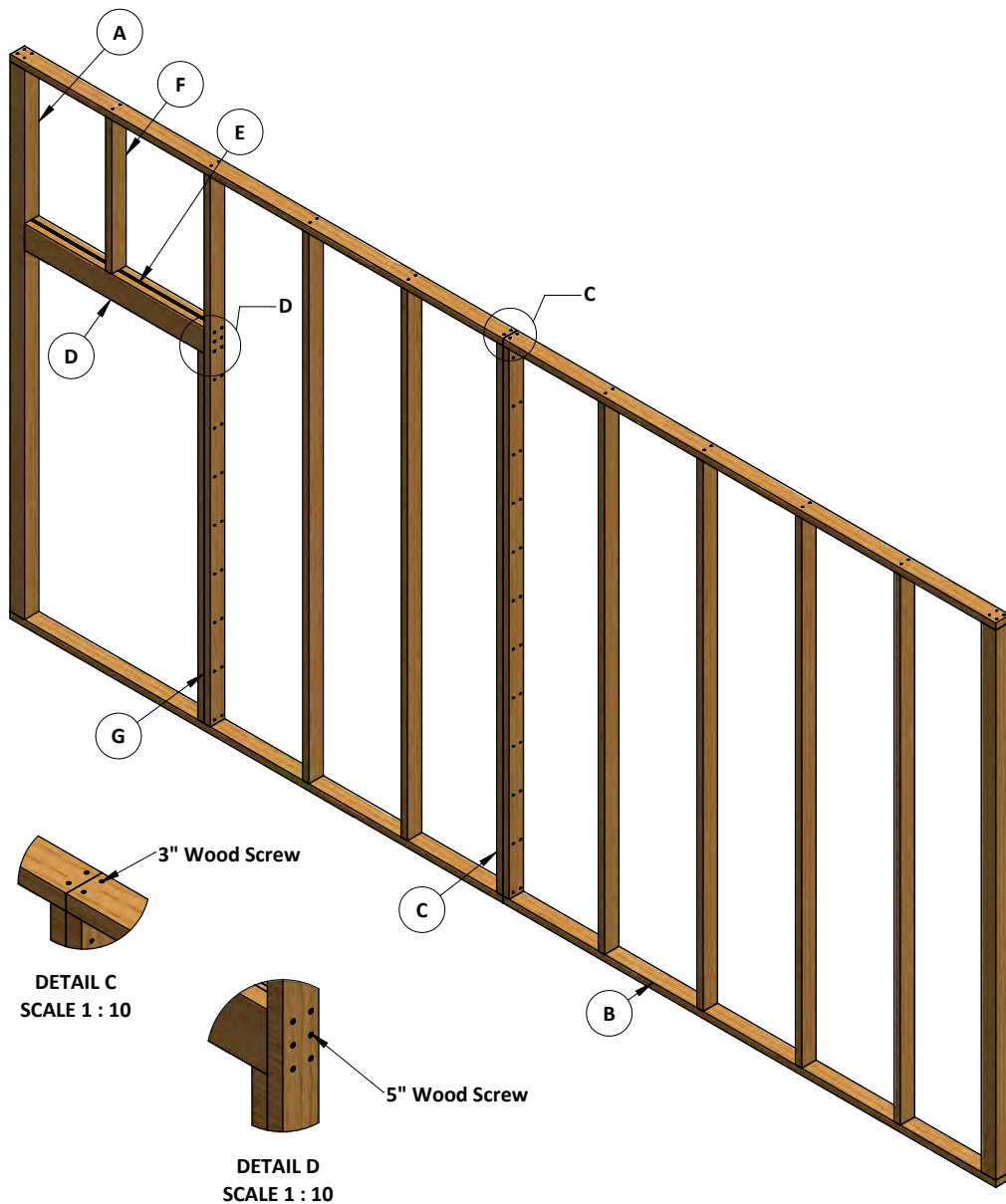

STEP 4

Fascias Assembly

4.1 Assemble the fascias using 1 x 6 lumber.

4.2 Secure the fascias with 2" wood screws.

Pos	Description	Material	Dimension	Qty
A	Fascias	1 x 6	10'	8

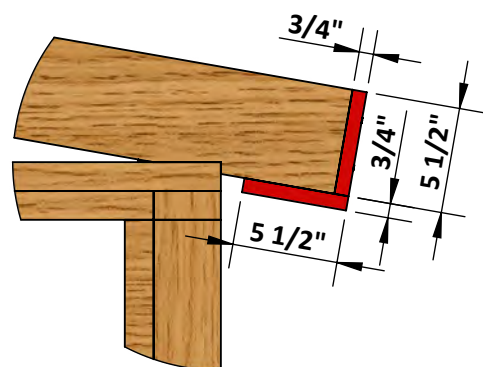
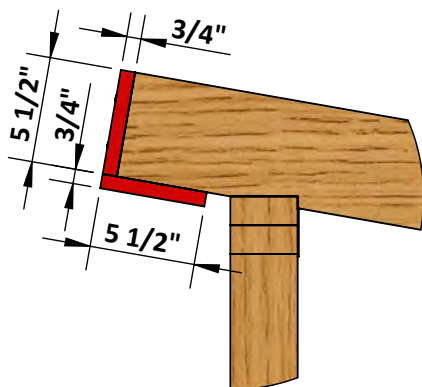
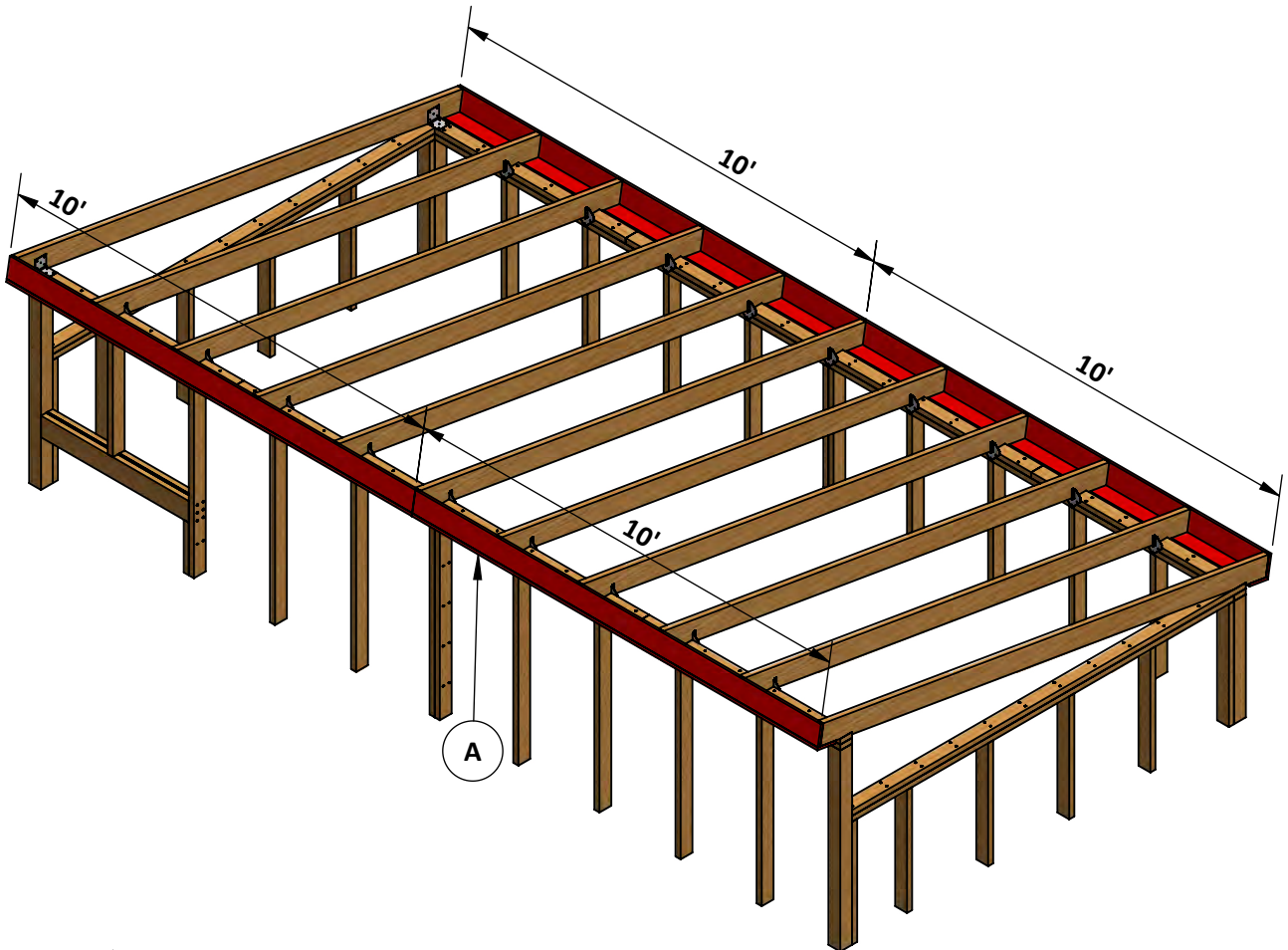

STEP 5

Metal Roof Assembly

- 5.1 Assemble the PBR panels in 19'-11" x 11'-3 5/8" roof area.
- 5.2 Assemble the eave flashing EF-3 according to node 1 below.
- 5.3 Assemble the gable rake GR-6 according to node 2 below.
- 5.4 Assemble the high side eave HS-2 according to node 3 below.
- 5.5 Secure the PBR panels, eave flashing, gable rake and high side eave with #9x1-1/2 screw and #12x1-1/2 screw.

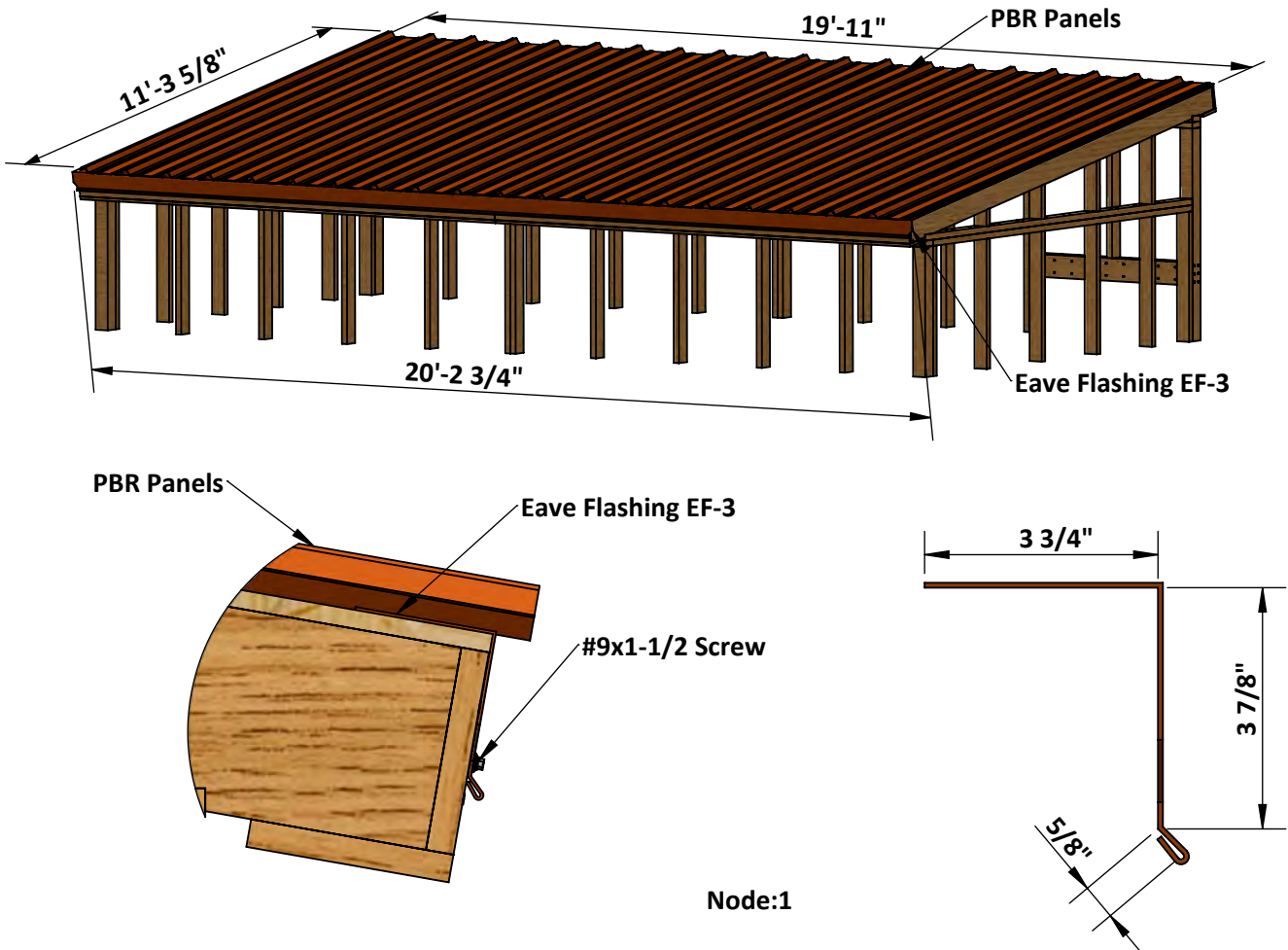

STEP 6

Placement of Nesting Box and Roosting bars in the Coop

6.1 Place the nesting box and the roosting bars at the suitable position in the chicken coop

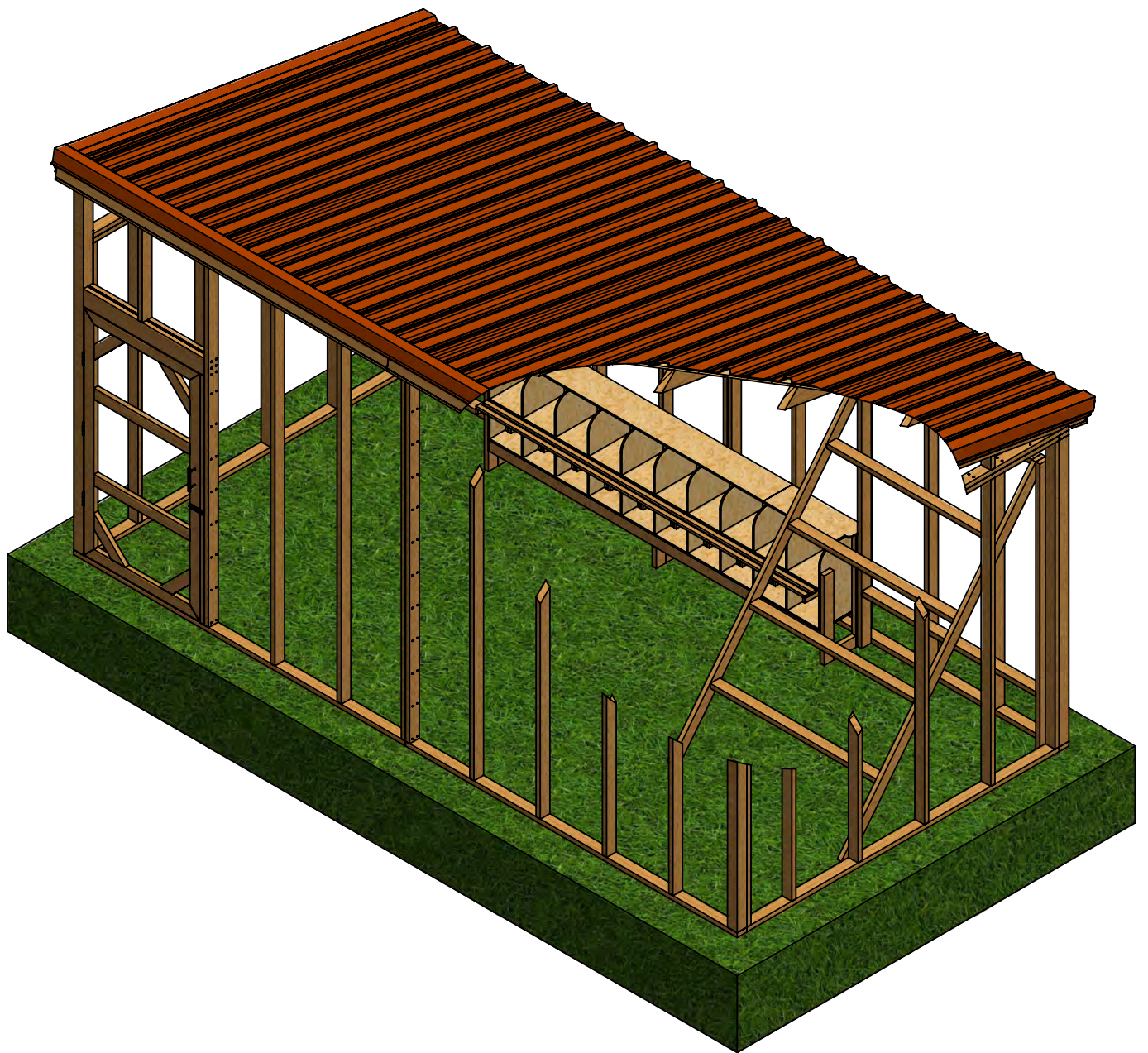

STEP 7

Final touches

Now that your chicken run is all done, you can decorate it using your favorite paint, stain, or preservative and prepare for petting chickens.

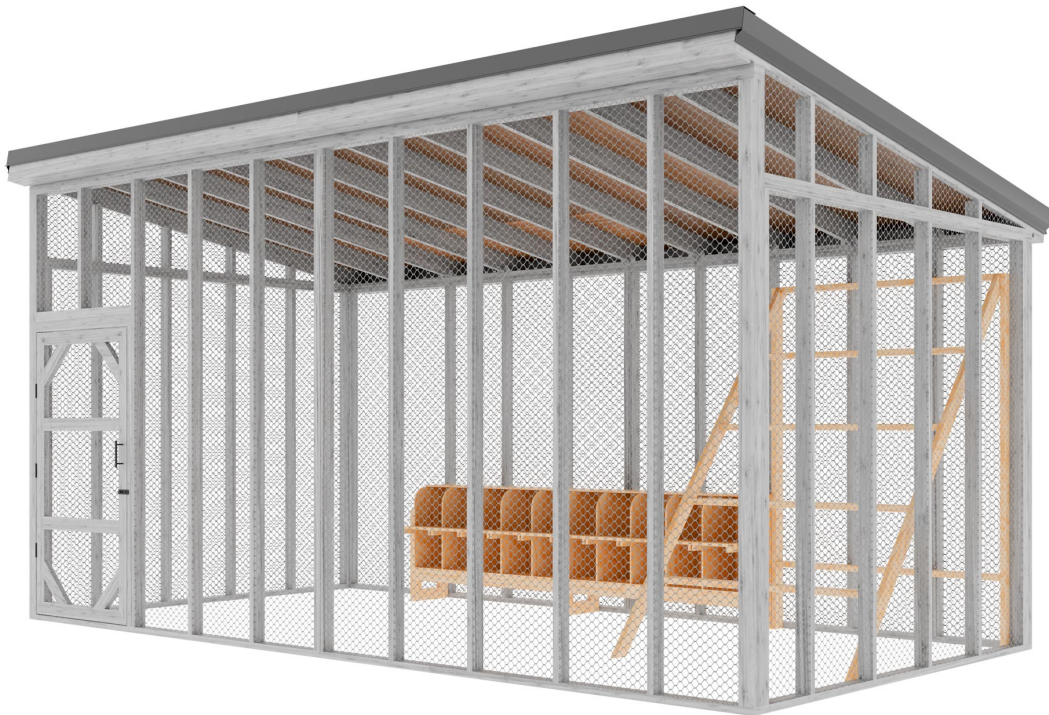

Free vs. Premium Plan: What's the Difference?

We offer both free and premium versions of our detailed shed plans, designed to fit your needs and budget. Check out the table below to see the key differences and choose the plan that's right for you:

Features	Free Plan	Premium Plan
Metric measurements	X	✓
Illustrations per Step	Limited	Every Step
Print Ready Format	X	✓
Step-by-Step Instructions	Basic	Comprehensive
Full Materials & Cutting List	X	✓
Additional Illustrations	X	✓
Additional Blueprints	X	✓
Tools List	X	✓
Fastening Elements List	X	✓
Technical Support	X	✓

[Try Premium Risk-Free](#)

30-day refund policy with no questions asked.



For more great **HOW-TO** plans please visit: <https://craft.camp>

Copyright

The text and illustrations that appear here are the exclusive property of craft.camp and are protected by federal copyright laws. The duplication, sale or distribution of any portion of these plans without prior written consent from the original designer will be subject to the appropriate penalties for copyright infringement. Sharing this plan on the web is only permitted with an indicated original source: <https://craft.camp>