

14'x20' Garden Shed Plan

Free vs. Premium Plan: What's the Difference?

We offer both free and premium versions of our detailed shed plans, designed to fit your needs and budget. Check out the table below to see the key differences and choose the plan that's right for you:

Features	Free Plan	Premium Plan
Steps Count	10	20
Illustrations per Step	Limited	Every Step
Print Ready Format	X	✓
Step-by-Step Instructions	Basic	Comprehensive
Full Materials & Cutting List	X	✓
Additional Illustrations	X	✓
Additional Blueprints	X	✓
Tools List	X	✓
Fastening Elements List	X	✓
Technical Support	X	✓

Try Premium Risk-Free

30-day refund policy with no questions asked.

14'x20' Garden Shed Material List

Site Preparation

- Concrete
- Bricks

Bottom Frame

- Pressure-Treated Lumber
- Plywood

Side Walls Frames

- Pressure-Treated Lumber

Shed's Roof

- Pressure-Treated Lumber
- Pressure-Treated Board
- Plywood
- Building paper
- Asphalt shingles
- Metal drip edge

Shed's Window Shutter

- Pressure-Treated Lumber

Shed's Front Window

- Pressure-Treated Lumber
- Window beading
- Glass

Shed's Door (2x)

- Pressure-Treated Lumber
- Plywood

Top Frame

- Pressure-Treated Lumber

Fasteners & Hardware

- Door hinges
- Door pulls
- Surface bolt
- Corner braces
- Wood square louver gable vent
- Galvanized nails
- Wood screws

Shed's Decorative Door Shutters

- Pressure-Treated Lumber

Door Ramp

- Pressure-Treated Lumber
- Plywood

Drainage System

- Pressure-Treated Lumber
- Half round gutter
- End pieces with outlet
- 45° elbow
- Drainage pipe
- Joint connector
- End cap
- Round hunger
- Wall fastener

STEP 1

Foundation Preparation

1.1 Clear the area where you want to build the shed and layout for the foundation. Use the below illustration as a guide.

1.2 For the foundation, dig the trenches at least 1' wide and 1' deep.

1.3 Fill the trenches to ground level with concrete and let cure, or harden. Since curing times vary between brands, read the packaging for recommended curing times.

1.4 Once the concrete has cured, use standard-sized bricks and lay them across the foundation. You will need roughly 270 bricks for this step.

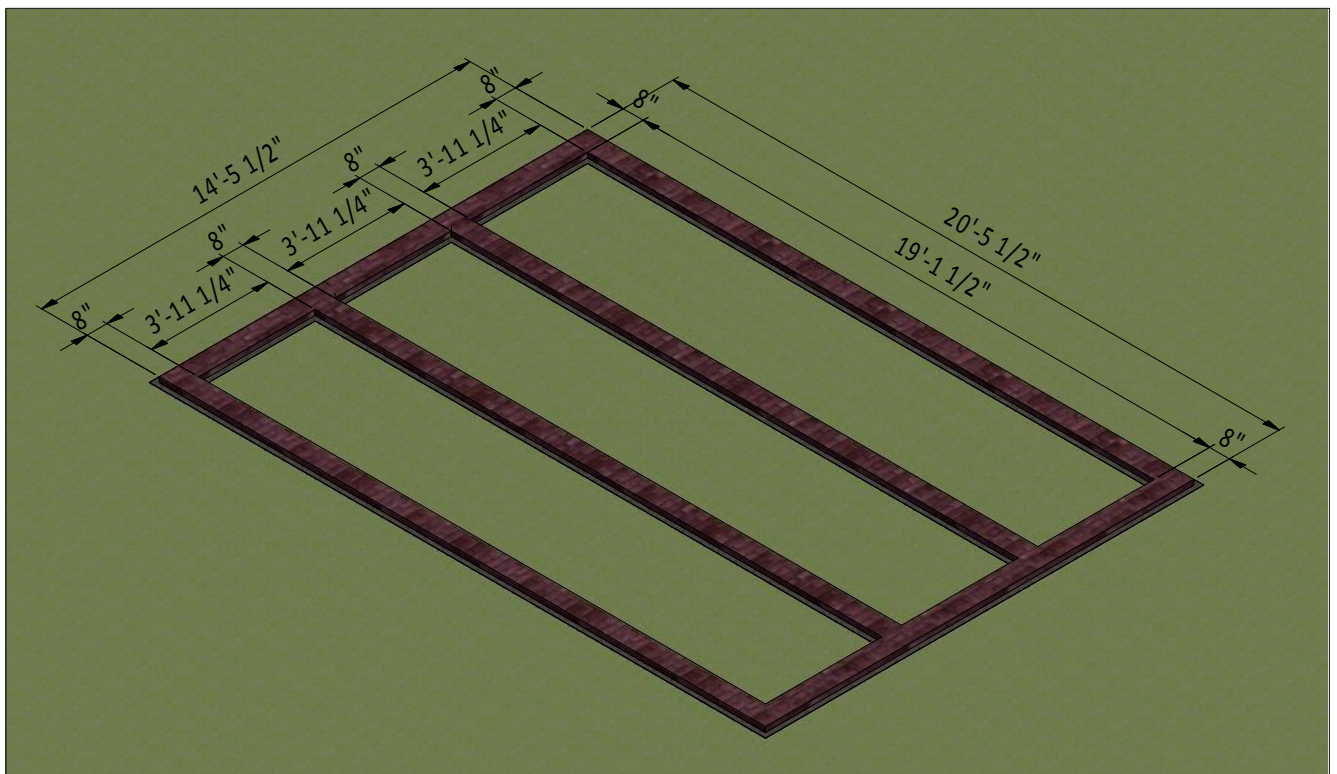
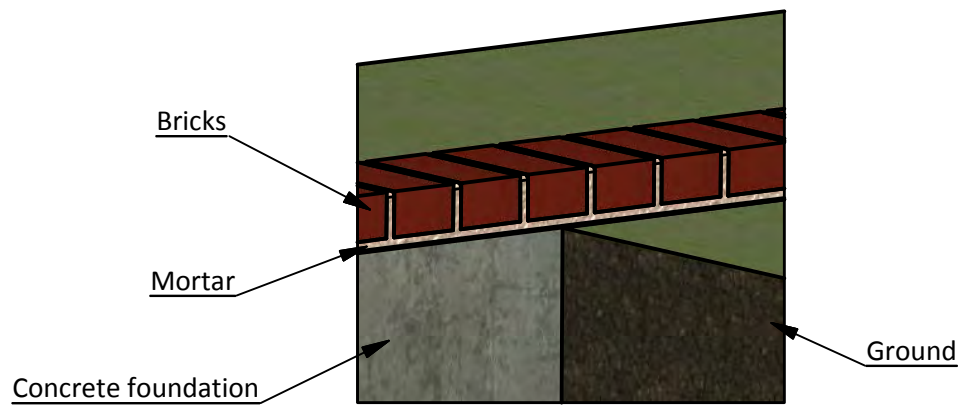

STEP 2

Framing the Floor

2.1 Assemble the frame using 1 1/2" x 7 1/4" pressure-treated lumber. You will need two boards cut to 20' that will be the rim joist and two boards cut to 13'-9" that will be the joist.

2.2 Secure the beams with 8x5" wood screws.

2.3 Using a speed square or carpenter's square, check the corners to make sure they are 90°.

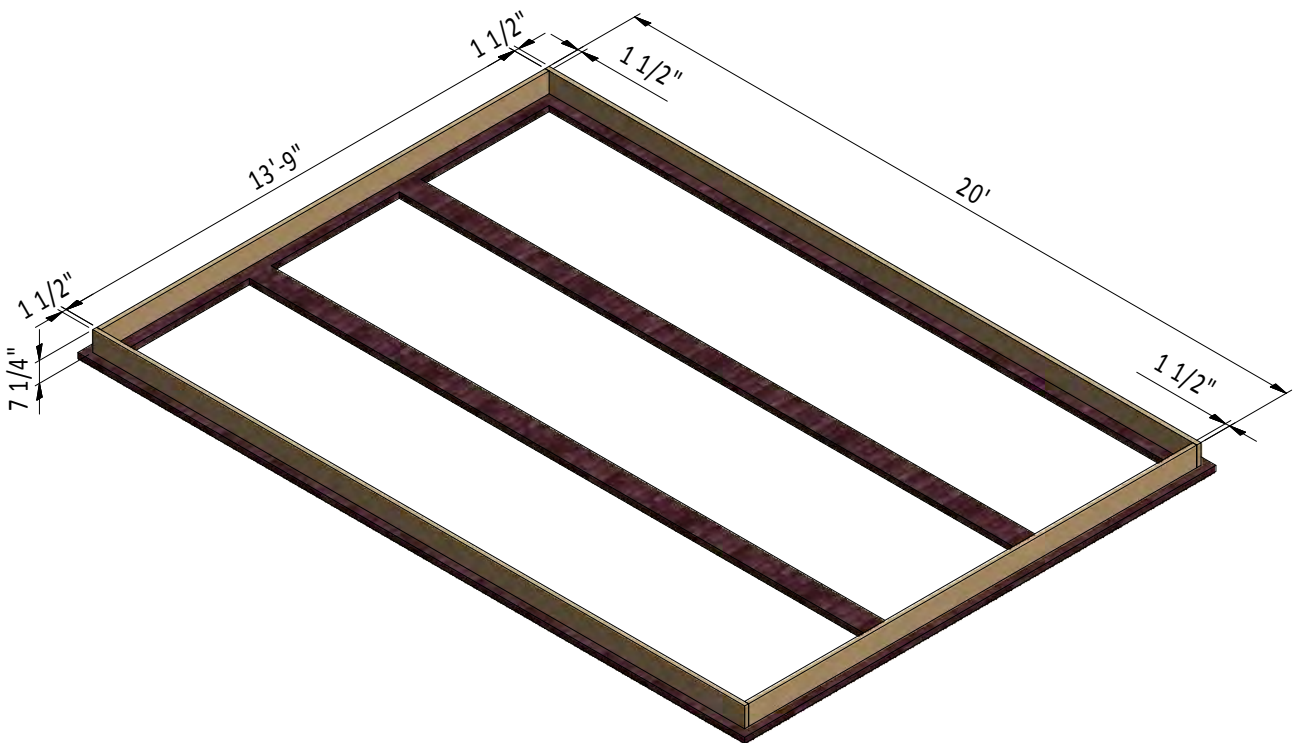

STEP 3

Assemble Front Wall Frame

3.1 Using 1 1/2" x 3 1/2" and 3 1/2" x 3 1/2" pressure-treated lumber, construct front wall frame using the drawing below as a reference. You will need fourteen boards cut to 7'-3" that will be studs, two boards cut to 7'-4" that will be the bottom plates, one board cut to 20' that will be the top plate, one board cut to 5'-4" that will be the door header, three boards cut to 1'-1" that will be cripple studs.

3.2 Connect the beams with 2x3" and 2x5" wood screws.

3.3 Using a speed square or carpenter's square, check the corners to make sure they are 90°.

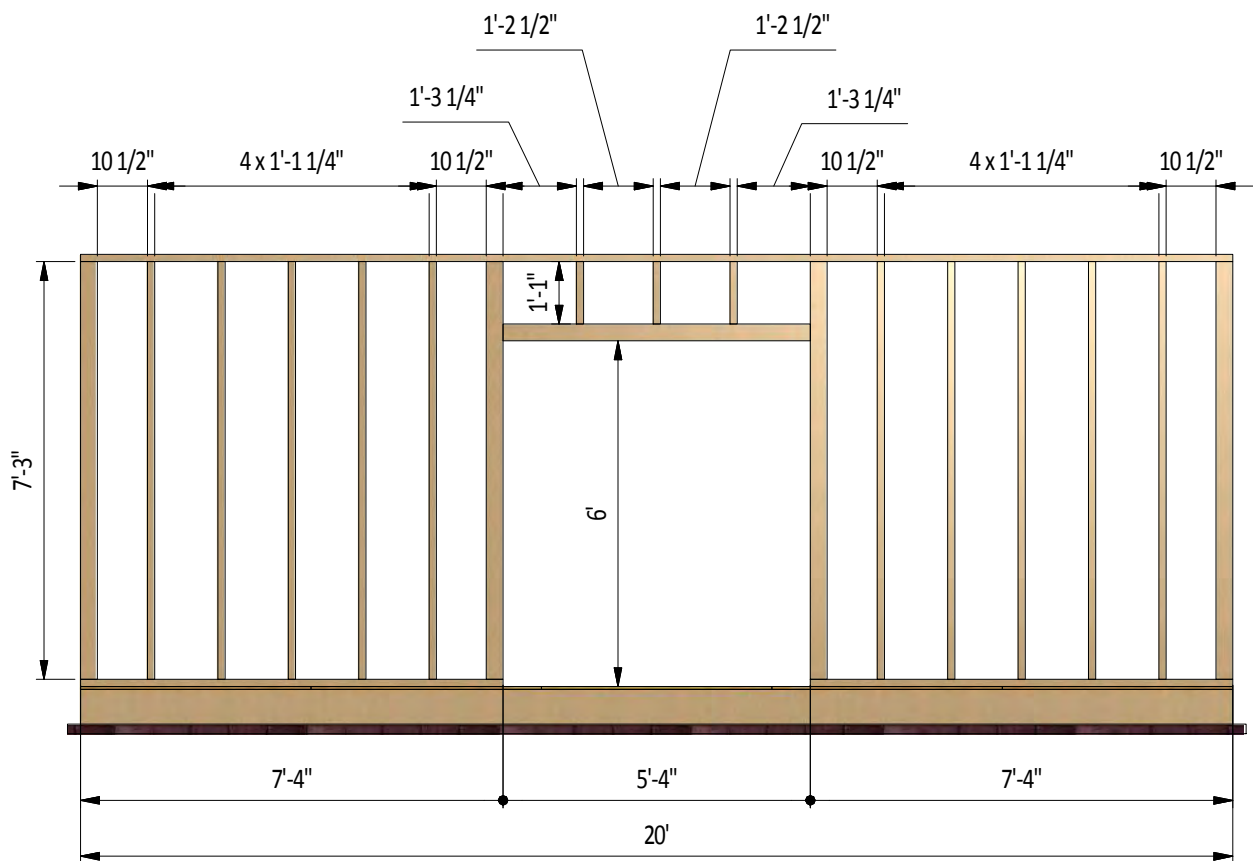

STEP 4

Assemble Back Wall Frame

4.1 Using 1 1/2" x 3 1/2" and 3 1/2" x 3 1/2" pressure-treated lumber, construct back wall frame using the drawing below as a reference. You will need sixteen boards cut to 8'-3" that will be the studs and two boards cut to 20' that will be the top and bottom plates.

4.2 Connect the beams with 2x3" wood screws.

4.3 Using a speed square or carpenter's square, check the corners to make sure they are 90°.

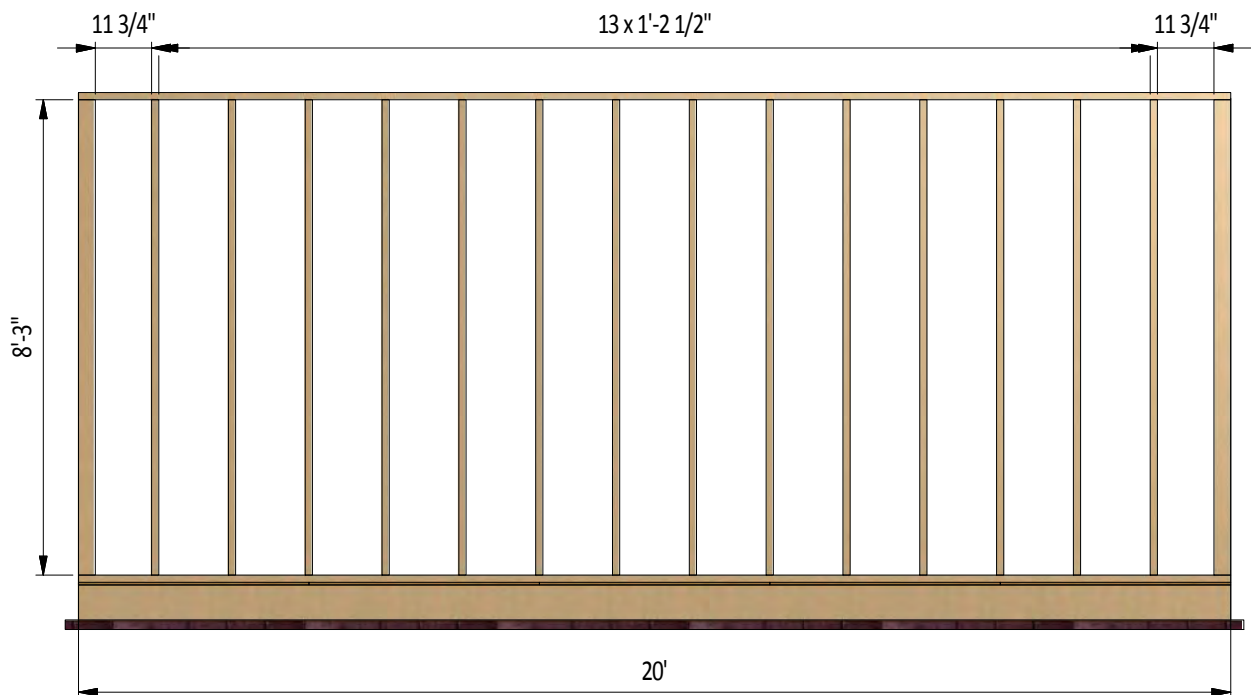

STEP 5

Assemble Right and Left Wall Frames

5.1 Using 1 1/2" x 3 1/2" pressure-treated lumber, construct side wall frames using the drawing below as a reference. You will need two boards cut to 11" that will be the cripple studs, two boards cut to 2'-9" and ten boards cut to 7'-3" that will be the studs, two boards cut to 3'-4" that will be the window header and rough sill and two boards cut to 13'-5" that will be the top and bottom plates.

5.2 Connect the beams with 2x3" wood screws.

5.3 Using a speed square or carpenter's square, check the corners to make sure they are 90°.

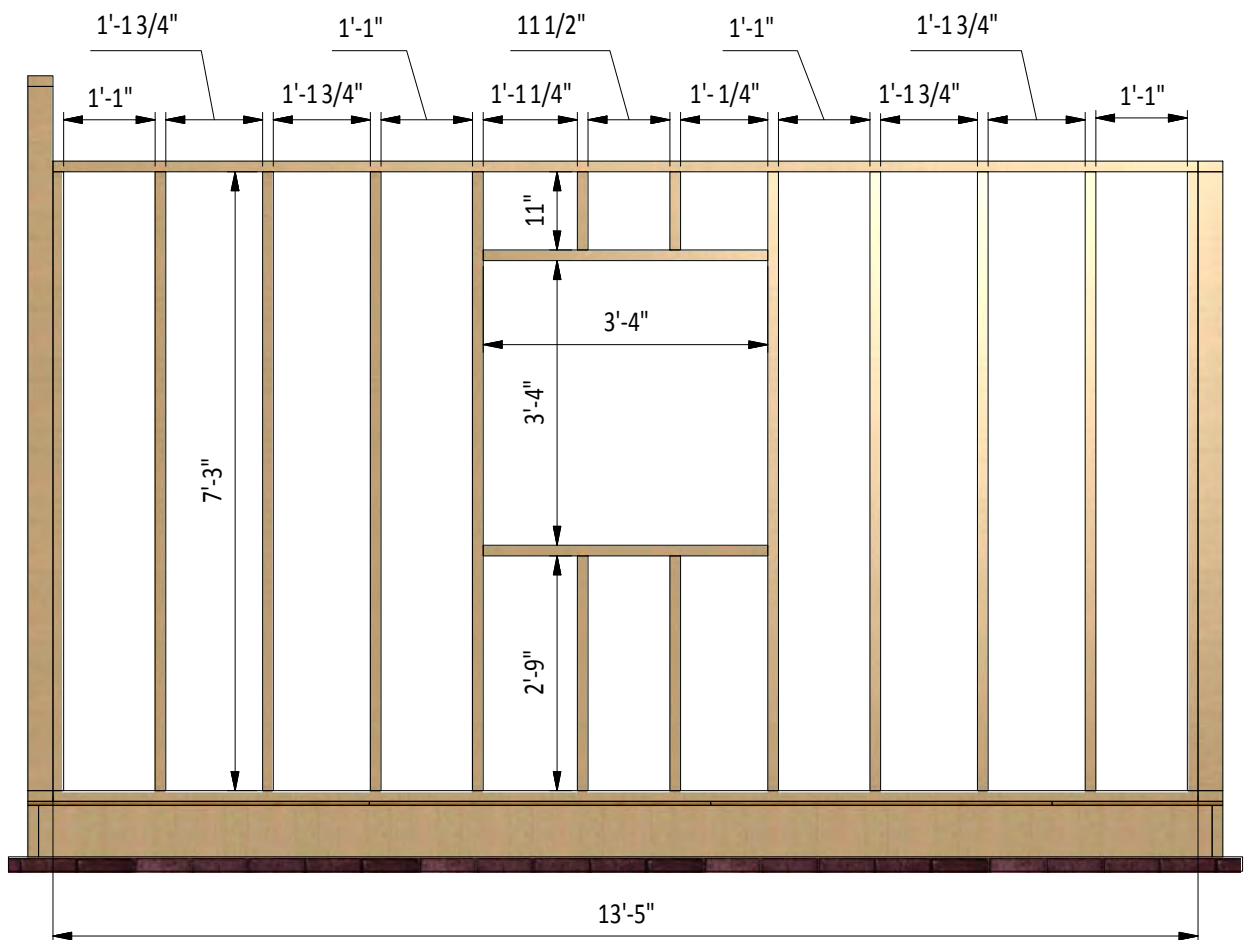

STEP 6

Assemble The Roof Frame

6.1 Using 1 1/2" x 5 1/2" pressure-treated lumber, cut fourteen rafters 15'-3 3/4" long according to the dimensions in drawing below. Cut the recesses in each beam for splicing connection with wall frames.

6.2 Connect the beams with a top frame with the help of 3" wood screws.

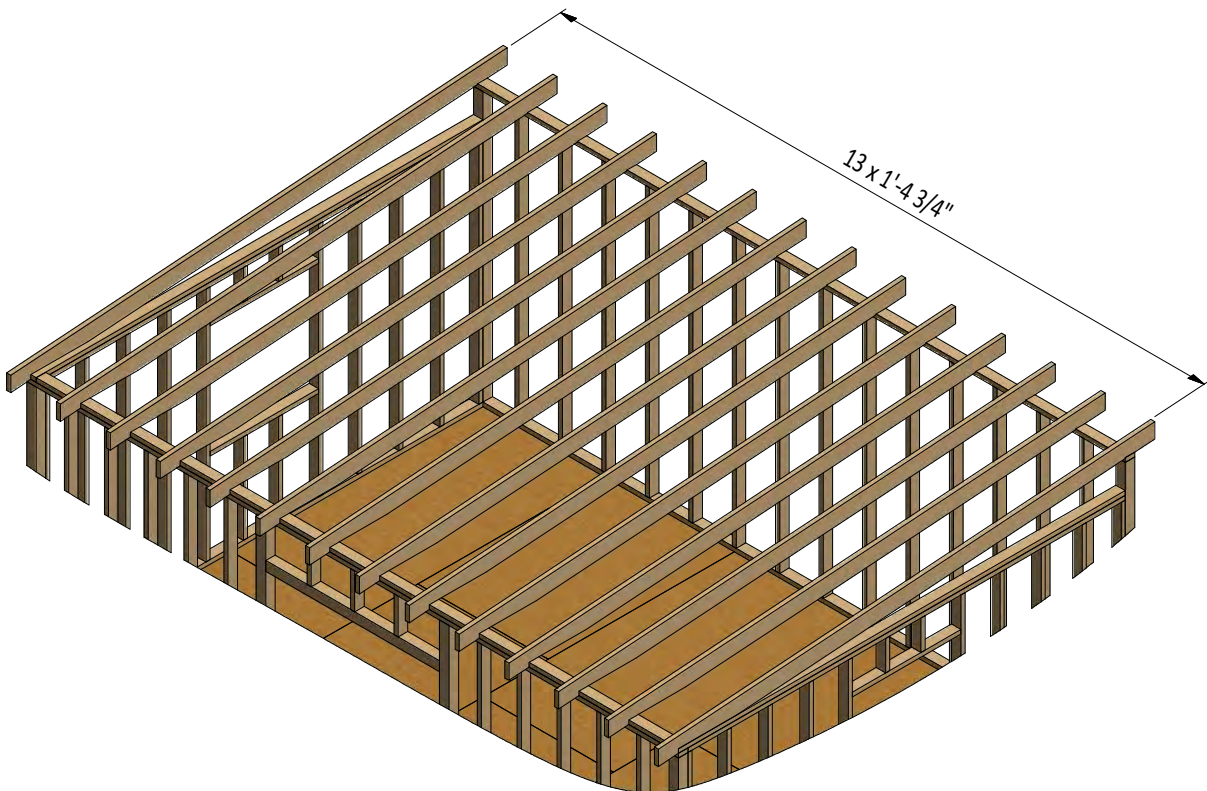

STEP 7

Assemble and Install Shed Doors

- 7.1** Build the door frames for the shed using 1 1/2" x 3 1/2" pressure-treated lumber and secure with 5" wood screws. You will need two boards cut to 5'-11 3/4" that will be the vertical girts and two boards cut to 2'-3/4" that will be the horizontal girts.
- 7.2** Prepare the 9/16" plywood sheet with dimensions 2'-7 3/4" x 5'-11 3/4" for the doors according to the drawing.
- 7.3** Use 2 1/2" x 3/4" pressure-treated lumber for the door trim and fasten with 2" wood screws. You will need two boards cut to 2'-2 3/4" and two boards cut to 5'-11 3/4".
- 7.4** Using 1/4" x 3/4" pressure-treated lumber, cut and install a starter course 2'-2 3/4" long.
- 7.5** For the exterior siding on the door, use 1/2" x 6" wood siding boards and the illustration below as a reference.
- 7.6** Assemble siding shields with 2" galvanized nails.
- 7.7** Install six 3" door hinges using 6x1" wood screws. Finish the doors installation by attaching 4" surface bolts and 6" door pulls.

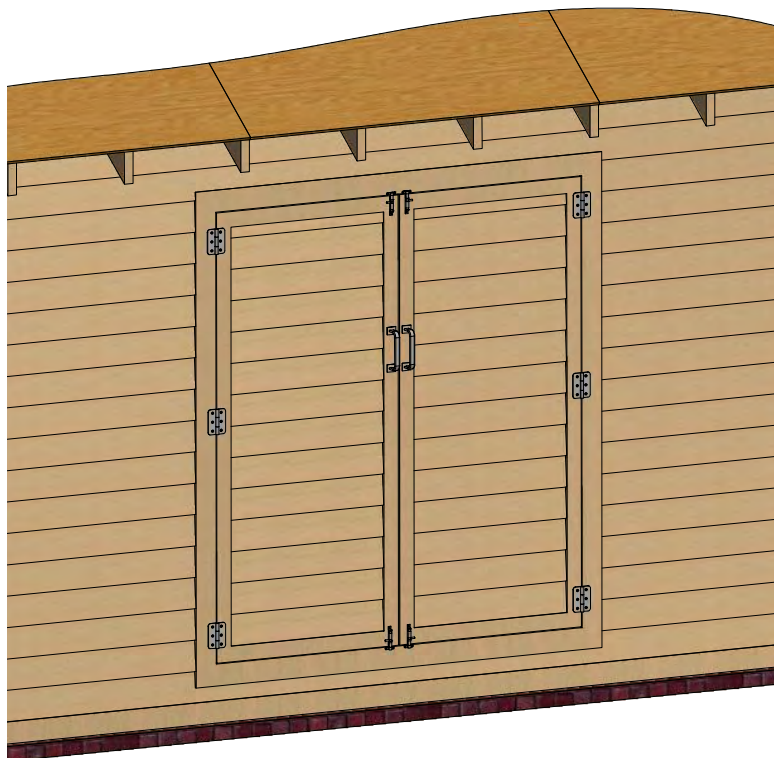

STEP 8

Roof Sheathing Installation

- 8.1 You will need 330 Sq Ft of asphalt shingle roofing.
- 8.2 Add the metal drip edge to the fascias.
- 8.3 Cover the plywood with building paper.
- 8.4 Install asphalt shingle roofing using an industrial stapler.

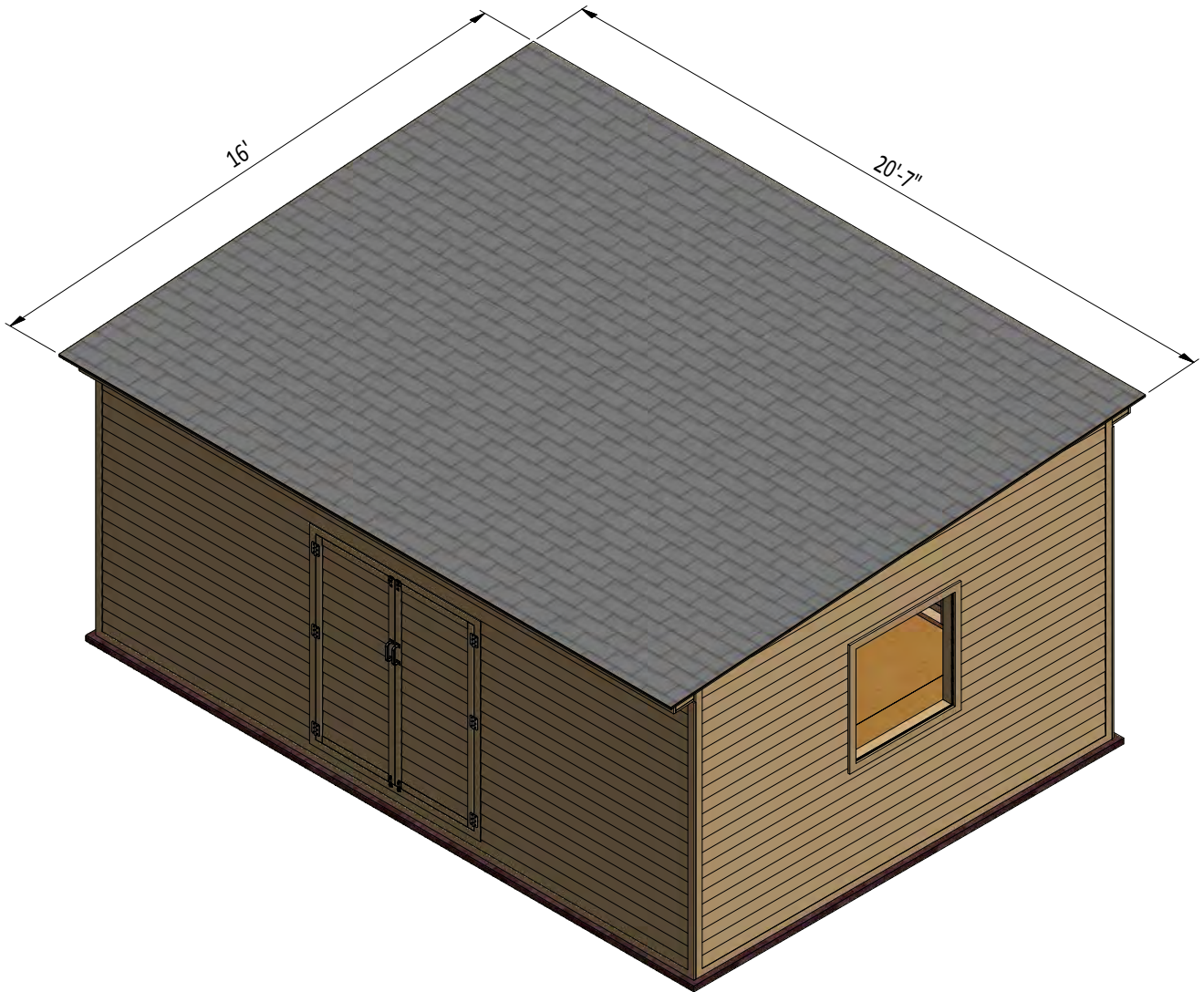

STEP 9

Assemble and Install Door Ramp

9.1 Assemble the five door ramp frames from pressure-treated lumber and secure with 3" and 5" wood screws. For each frame you will need one 1 1/2" x 1 1/2" board cut to 1'-8"; one 1 1/2" x 2 1/2" board cut to 3'-3/4" and one 1 1/2" x 3 1/2" board cut to 6 1/4".

9.2 Connect and secure all frames using one 1 1/2" x 2 1/2" board 5'-9" long and 3" wood screws.

9.3 Cut the 9/16" plywood sheet with dimensions 3'-3/4" x 5'-9" for the top plane and two sheets with dimensions 9 1/4" x 2'-9 1/2" for the sides.

9.4 Assemble siding shields with 2" galvanized nails.

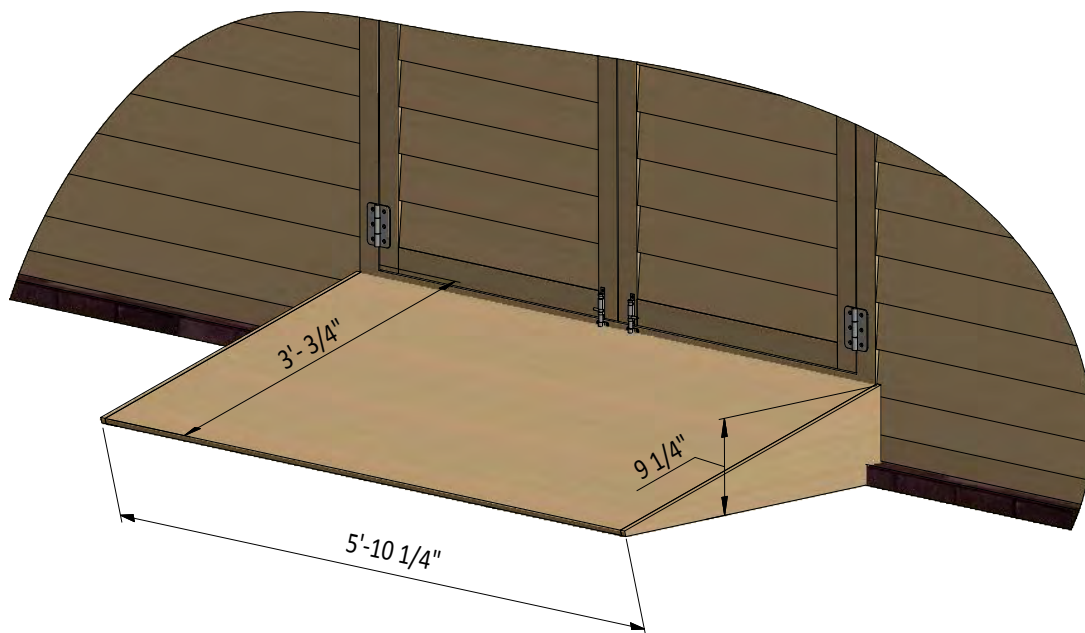

STEP 10

Window Installation for Left and Right Walls

It is necessary to prepare 2 windows.

10.1 Using 1 1/2" x 2 1/2" pressure-treated lumber, assemble the outer frame for the window as shown in the drawing below. You will need two boards cut to 3'-1" that will be the vertical girts and two boards cut to 3'-4" that will be the horizontal girts. Additionally, add vertical 2'-11 1/2" long and horizontal 3'-1" long supports using 3/4" x 1" lumber and cut the recesses for the window hinges.

10.2 Use 1 1/2" x 1 1/2" pressure-treated material to make the inner frame and secure with 3" wood screws. You will need two boards cut to 2'-9 3/4" that will be the vertical girts and two boards cut to 3'-3/4" that will be the horizontal girts. Mill a recess for the glass panes and for the hinges.

10.3 Use 1 1/4" x 1 1/2" pressure-treated material to make the inner frame supports and secure with 3" wood screws. You will need two boards cut to 2'-9 3/4" and mill a recess for interconnection.

10.4 Prepare and install glass into inner frame groove and fasten it by window beading from four sides. Use 1/2" galvanized nails.

10.5 Install two hinges 3" with 6x1" wood screws and assemble the window. Install a lock on the inner side of the window.



STEP 11

Assemble and Install Window Shutters

It is necessary to prepare 4 windows shutters.

11.1 Assemble frames using $\frac{3}{4}$ " x $1\frac{1}{2}$ " pressure-treated lumber and secure with 3" wood screws. You will need one board cut to $1' - 4\frac{3}{4}$ " two boards cut to $3' - 3\frac{3}{4}$ " that will be the vertical girts and two boards cut to $1' - 7\frac{3}{4}$ " that will be the horizontal girts.

11.2 Mill a recess along the vertical girts for the jalousies.

11.3 Use $\frac{1}{4}$ " x $1\frac{1}{2}$ " pressure-treated lumber for the jalousies. You will need twenty two boards cut to $1' - 5\frac{3}{4}$ ".

11.4 Install two 3" door hinges using 6x1" wood screws.

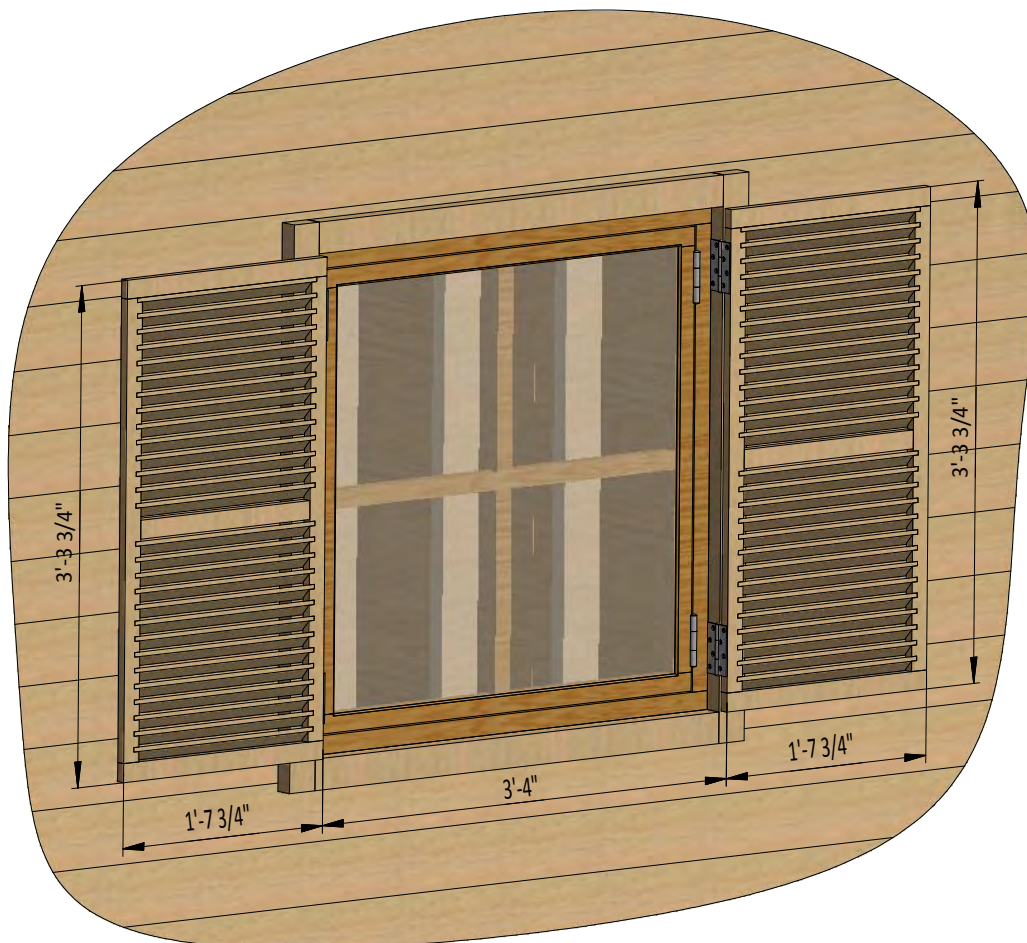

STEP 12

Assemble and Install Decorative Door Shutters

It is necessary to prepare two decorative door shutters.

12.1 Assemble front frame using 1 1/2" x 1 1/2" pressure-treated lumber and secure with 3" wood screws. You will need two boards cut to 6'-7" that will be the vertical girts and two boards cut to 1'-5 1/2" that will be the horizontal girts.

12.2 Assemble back frame using 3/4" x 2 1/2" pressure-treated lumber and secure with 5" wood screws. You will need two boards cut to 6'-7" that will be the vertical girts and two boards cut to 1'-3 1/2" that will be the horizontal girts.

12.3 Use 3/4" x 3/4" pressure-treated lumber for the lattice. You will need thirty six boards cut to 2'-3/4". Assemble according to the drawing.

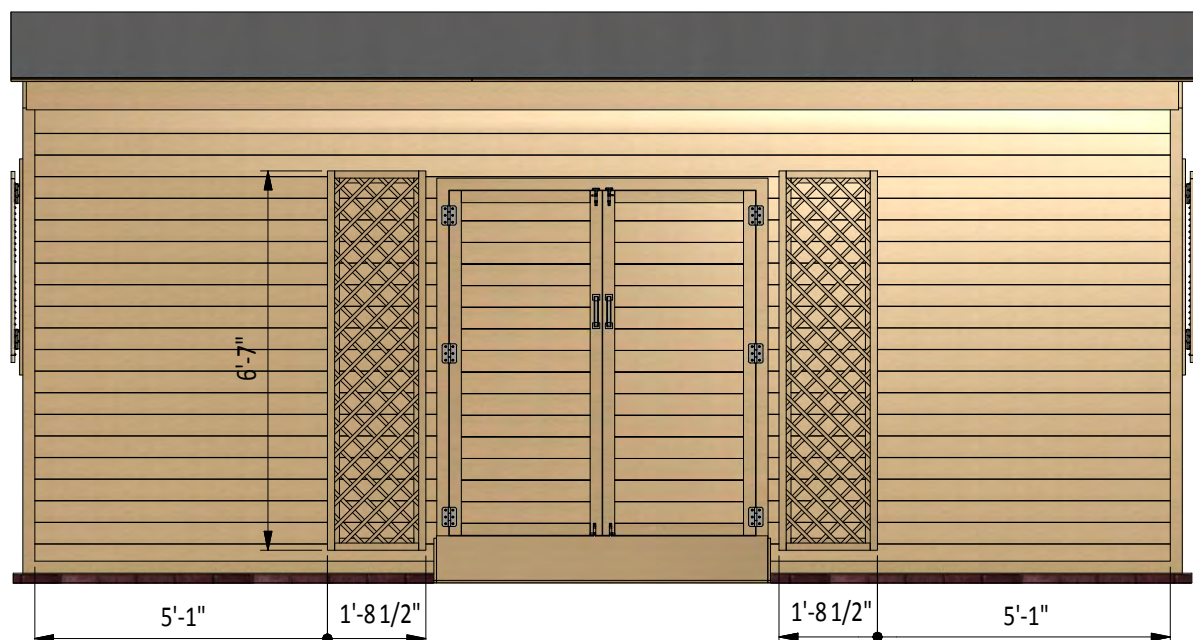

STEP 13

Assemble and Install Roof Drainage System

13.1 Assemble roof drainage system on the front fascia board. You will need 5" half round gutter 18'-3" long, two end pieces with the outlet, six 45° elbows, two 3" pipes 6' long, two joint connectors and two end caps.

13.2 Fasten the round gutter to the fascia with the round hangers.

13.3 Fasten the vertical pipe section with the four wall fasteners.

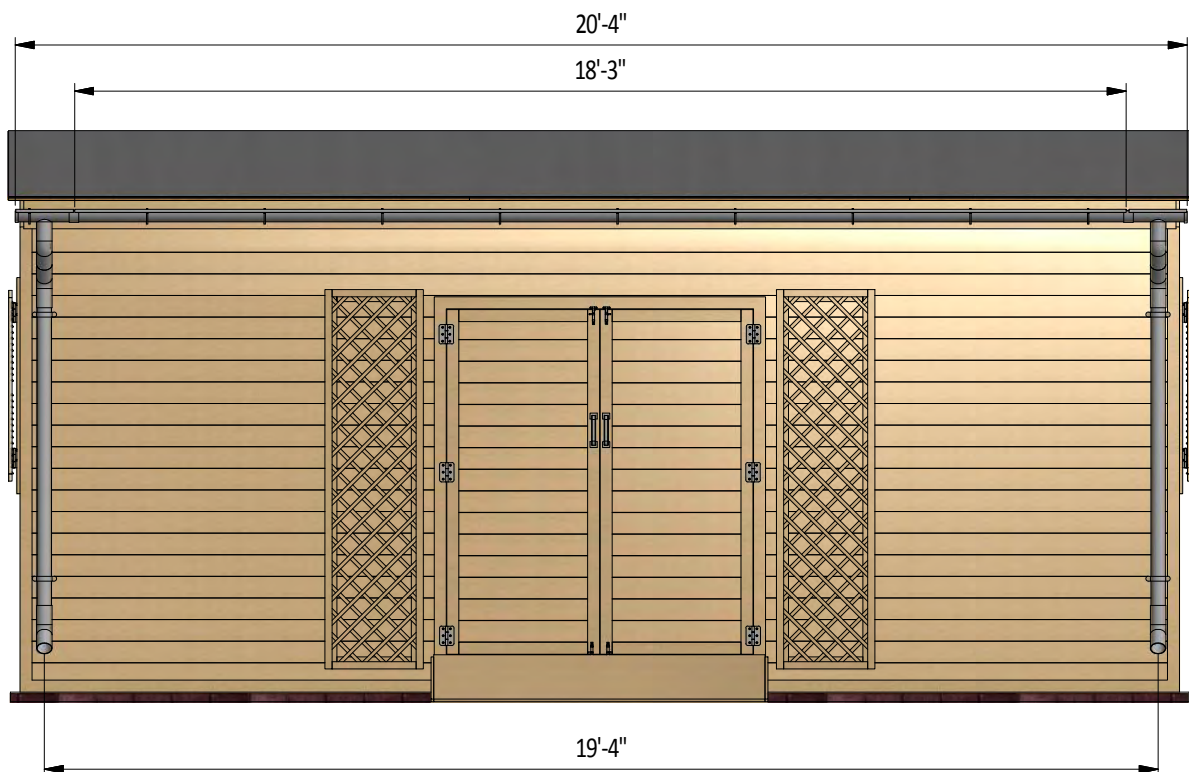

STEP 14

Shed Decoration

Now that your shed is all done, you are ready to decorate it any way you want using your favourite paint, stain, or preservative.

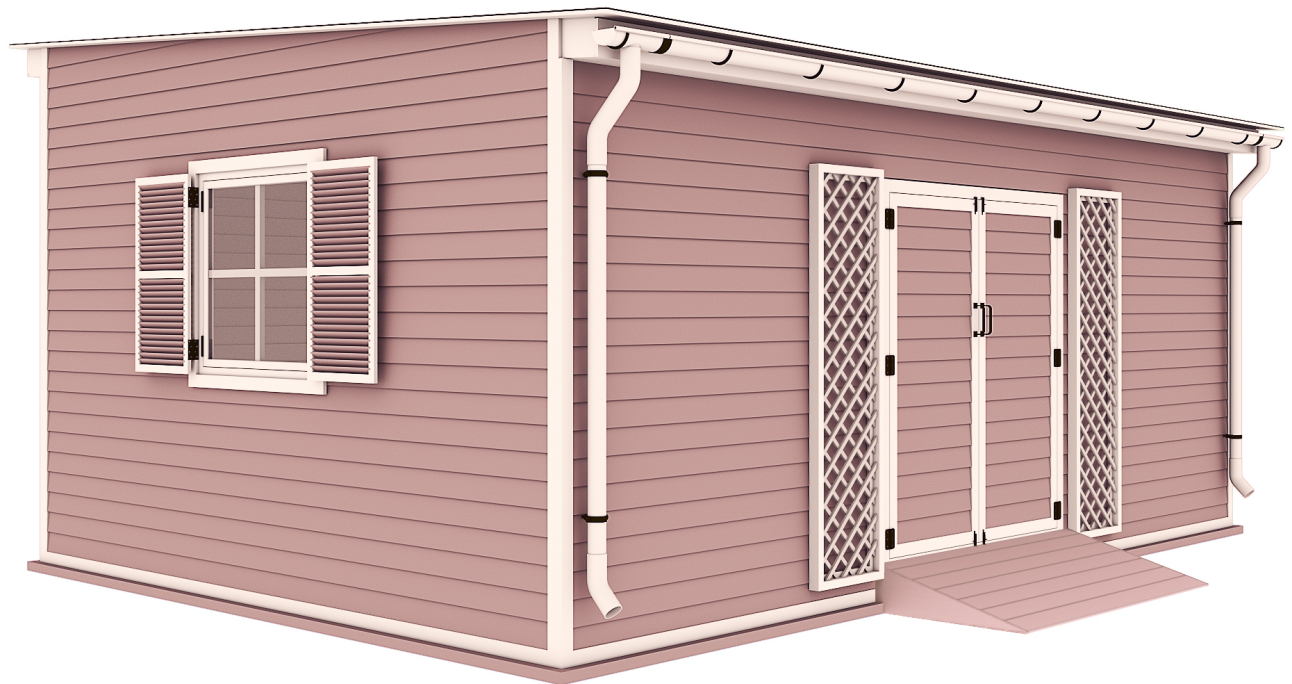

Free vs. Premium Plan: What's the Difference?

We offer both free and premium versions of our detailed shed plans, designed to fit your needs and budget. Check out the table below to see the key differences and choose the plan that's right for you:

Features	Free Plan	Premium Plan
Steps Count	10	20
Illustrations per Step	Limited	Every Step
Print Ready Format	X	✓
Step-by-Step Instructions	Basic	Comprehensive
Full Materials & Cutting List	X	✓
Additional Illustrations	X	✓
Additional Blueprints	X	✓
Tools List	X	✓
Fastening Elements List	X	✓
Technical Support	X	✓

Try Premium Risk-Free

30-day refund policy with no questions asked.



For more great **HOW-TO** plans please visit: <https://craft.camp>

Copyright

The text and illustrations that appear here are the exclusive property of craft.camp and are protected by federal copyright laws. The duplication, sale or distribution of any portion of these plans without prior written consent from the original designer will be subject to the appropriate penalties for copyright infringement. Sharing this plan on the web is only permitted with an indicated original source: <https://craft.camp>